

# Innova-Sonic® Model 205i

## Dedicated & Thermal Energy BTU

### Instruction Manual

Version IM-205i, Rev. G.1, October 2011



## GLOBAL SUPPORT LOCATIONS: WE ARE HERE TO HELP!

### CORPORATE HEADQUARTERS

5 Harris Court, Building L Monterey, CA 93940

Phone (831) 373-0200 (800) 866-0200 Fax (831) 373-4402

[www.sierrainstruments.com](http://www.sierrainstruments.com)

### EUROPE HEADQUARTERS

Bijlmansweid 2 1934RE Egmond aan den Hoef The Netherlands

Phone +31 72 5071400 Fax +31 72 5071401

### ASIA HEADQUARTERS

Rm. 618, Tomson Centre, Bldg A, 188 Zhang Yang Road

Pu Dong New District, Shanghai, P.R. China

Phone: + 8621 5879 8521 Fax: +8621 5879 8586

## © COPYRIGHT SIERRA INSTRUMENTS 2011

No part of this publication may be copied or distributed, transmitted, transcribed, stored in a retrieval system, or translated into any human or computer language, in any form or by any means, electronic, mechanical, manual, or otherwise, or disclosed to third parties without the express written permission of Sierra Instruments. The information contained in this manual is subject to change without notice.

## TRADEMARKS

Innova-Sonic® is a Registered Trademark of Sierra Instruments, Inc. Other product and company names listed in this manual are trademarks or trade names of their respective manufacturers.

## Important Customer Notice

Thank you for choosing the Innova-Sonic® Model 205i Dedicated & Energy BTU Transit-Time Ultrasonic Flow Meter with SLSI CMOS and low-voltage wide-pulse sending technology. This manual contains important information about your meter. Before installing and operating this flow meter, please read this manual carefully and follow its instructions.

- ✓ Sierra has verified the conformity between the contents in this manual and the hardware and software described. However, errors may still exist. We regularly review the materials covered in this manual and correct errors with revisions. Any suggestions for improvement will be appreciated.
- ✓ Go to [www.sierrainstruments.com/products/downloads.html](http://www.sierrainstruments.com/products/downloads.html) for a most current electronic version of this manual.
- ✓ We reserve the right to change the content of this manual without prior notification.
- ✓ [If you have any questions or problems regarding this manual, please contact Sierra's Customer Service](#)

Customer Service Department:

Toll Free: 800-866-0200 Phone: +831-373-0200 Fax: 831-373-4402

Email: [service@sierrainstruments.com](mailto:service@sierrainstruments.com)

### WARNINGS IN THIS MANUAL

Warning, attention, and note statements are used throughout this book to draw your attention to important information.



---

#### WARNING

“Warning” statement appears with information that is important to protect people and equipment from damage. Pay very close attention to all warnings that apply to your application. **Failure to comply with these instructions may damage the meter and personal injury.**

---



---

#### ATTENTION

“Attention” statements in this manual indicate that failure to comply with stated instructions **may result in damage to the meter or faulty operation of the flow meter.**

---



---



#### NOTE

“Note” indicates that ignoring the relevant requirements or precautions **may result in flow meter damage or malfunction.**

---

# Product Components

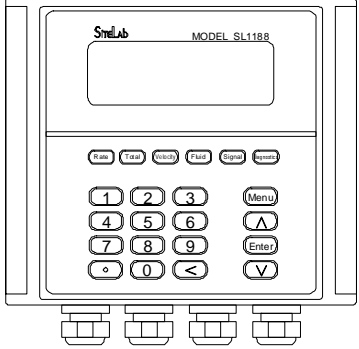
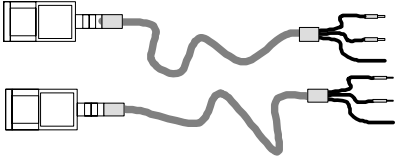
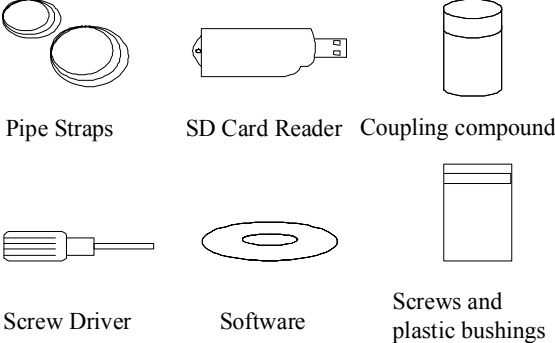
Inspection should be made before installing the Innova-Sonic 205i. Check to see if the spare parts are in accordance with the packing list. Make sure that there is no damage to the enclosure due to a loose screw or loose wire, or other damage that may have occurred during transportation. Any questions, please contact your representative as soon as possible.

Transmitter	Transducers
	
Accessories	Documents
 <p>Pipe Straps      SD Card Reader      Coupling compound</p> <p>Screw Driver      Software      Screws and plastic bushings</p>	 <ol style="list-style-type: none"> <li>1. Instruction Manual</li> <li>2. Packing List</li> <li>3. Certified 3-Point Factory Calibration</li> <li>4. Position drawing</li> <li>5. Application Worksheet</li> </ol>

# Content

<b>1. Transmitter Installation and Connect</b> .....	<b>7</b>
1.1. Inspection prior to Transmitter Installation.....	7
1.2. Power Supply Connecting.....	7
1.2.1 <i>Direct Mount Method</i> .....	7
1.2.2 <i>Connecting the Wiring</i> .....	8
1.3. Powering On .....	8
1.4. Keypad Functions.....	9
1.5. Keypad Operation.....	9
1.6. Flow Meter Window Descriptions .....	10
<b>2. Pipe Parameter Entry Shortcuts</b> .....	<b>11</b>
<b>3. Measurement Site Selection</b> .....	<b>13</b>
<b>4. Transducer Installation</b> .....	<b>14</b>
4.1. Installing the Transducers.....	14
4.1.1 <i>Transducer spacing</i> .....	14
4.1.2 <i>Transducer Mounting Methods</i> .....	14
4.1.3 <i>V Method</i> .....	14
4.1.4 <i>Z Method</i> .....	15
4.1.5 <i>N Method (not commonly used)</i> .....	15
4.2. Transducer Mounting Inspection.....	15
4.2.1 <i>Signal Strength</i> .....	16
4.2.2 <i>Signal Quality (Q value)</i> .....	16
4.2.3 <i>Total Time and Delta Time</i> .....	16
4.2.4 <i>Transit Time Ratio</i> .....	16
<b>5. Operating Instructions</b> .....	<b>18</b>
5.1. System Normal Identification .....	18
5.2. Zero Set Calibration .....	18
5.3. Scale Factor.....	18
5.4. System Lock (Unlock).....	19
5.5. 4-20mA Current Loop Verification.....	19
5.6. Frequency Output .....	19
5.7. Totalizer Pulse Output.....	20
5.8. Alarm Programming.....	20
5.9. Batch Controller.....	21
5.10. Analog Output Calibration.....	21
5.11. Use of the Memory Card.....	22
5.11.1 <i>Specifications</i> .....	22

5.11.2	<i>Install or Remove the SD card while the meter is powered on</i> .....	23
5.11.3	<i>Reading the SD Data Externally</i> .....	23
5.11.4	<i>Reading the SD Data Internally with the Instrument powered ON</i> .....	23
5.11.5	<i>File converter tool</i> .....	25
5.12	Recover the Factory Default.....	25
5.13	ESN.....	26
<b>6.</b>	<b>Windows Display Explanations</b> .....	<b>27</b>
6.1.	Windows Display Codes.....	27
6.2.	Display explanation.....	28
<b>7.</b>	<b>Error Diagnoses</b> .....	<b>48</b>
7.1.	Table 1. Self-diagnoses and Error Solutions (upon power on).....	48
7.2.	Table 2. Error codes and solutions (during operation).....	49
7.3.	Frequently Asked Questions and Answers.....	50
<b>8.</b>	<b>Product Overview</b> .....	<b>51</b>
8.1.	Introduction.....	51
8.2.	Features of Innova-Sonic 205i.....	51
8.3.	Theory of Operation.....	51
8.4.	Applications.....	52
8.5.	Specifications.....	53
<b>9.</b>	<b>Appendix1 - Flow Application Data</b> .....	<b>55</b>
9.1.	Sound Velocity and Viscosity for Fluids Commonly Used.....	55
9.2.	Sound Velocity for Various Materials Commonly Used.....	55
9.3.	Sound Velocity in Water (1 atm) at Different Temperatures.....	56
<b>10.</b>	<b>Appendix2 – Energy Meter</b> .....	<b>57</b>
10.1.	Energy Meter Function.....	57
10.2.	Wiring.....	57
10.3.	Energy Calculation Method.....	57
10.4.	Set Temperature Value Range.....	58
<b>11.</b>	<b>Appendix3—RTD Module and PT100 Wiring (Module optional)</b> .....	<b>59</b>
11.1.	RTD Energy Meter Function.....	59
11.2.	Wiring.....	59
11.3.	Energy Measurement Methods.....	60
11.4.	Temperature Range Adjustment.....	60
11.5.	RTD Module Calibration Methods.....	61
11.6.	Installation of RTD Module.....	62
<b>12.</b>	<b>Appendix4 - Wetted Transducer</b> .....	<b>63</b>

- 12.1. Overview..... 63
- 12.2. Measurement Point Selection..... 63
- 12.3. Determining Transducer Spacing & Transducer Installation ..... 64
- 12.4. Transducer Mounting Methods..... 65
  - 12.4.1 Z Mounting Method..... 65
  - 12.4.2 V Mounting Method..... 65
- 13. Appendix5 - Serial Interface Network Use and Communications Protocol ..... 66**
  - 13.1. Overview..... 66
  - 13.2. Serial Port Definitions ..... 66
  - 13.3. Direct Connection via RS232 to the Host Device ..... 67
  - 13.4. Communications Protocol and The Use ..... 67
    - 13.4.1 FUJI Protocol..... 67
      - 13.4.1.1. Function Prefix and Function Sign..... 69
      - 13.4.1.2. Key Code..... 71
    - 13.4.2 MODBUS-C Protocol..... 72
    - 13.4.3 MODBUS-I Communication Protocol..... 73

Update Information:

---

---

---

---

# 1. Transmitter Installation and Connect

## 1.1. Inspection prior to Transmitter Installation

You will find a “Position Drawing” in the packing. Please use it as a template in the place that you are going to install the flow meter. Then drill 4 installation holes at the screw position shown on the drawing with the 5.5mm drill.

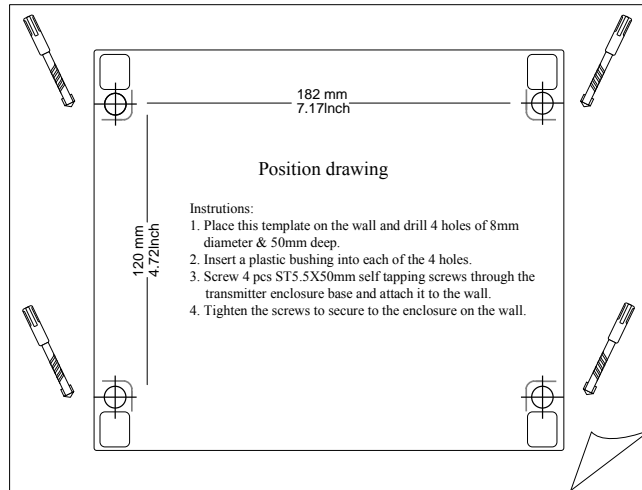

Take out the enclosed screws and plastic bushings. Insert the plastic bushings into the installing holes. Then open the two aluminum pieces on the two sides of the top cover. Put the flow meter into the position and screw it in.



### Attention

When installing please ensure the front cover is secure and will not fall open.

## 1.2. Power Supply Connecting

### 1.2.1 Direct Mount Method

Customers should pay special attention to specify the desired power supply when placing an order. Factory standard power supply is 90~245 VAC.

Observe the following precautions for installation procedures outlined in this chapter:

Ensure that power connections are made in accordance with the indications shown on the connection terminals.

Transmitters can be powered by two different power supplies: 90~245VAC or 10-36VDC.

## 1.2.2 Connecting the Wiring

Once the electronics enclosure has been installed, the flow meter wiring can be connected.  
Power board wiring ports, from left to right, are as follows:

Connect to AC power (90-245V), DC power (10-36V), Relay Output, OCT Output, Analog Input, Transducer wiring, 4-20mA Output, RS232 Output, RS485 Output.

For double-shielded transducer cable: "-" on the black wire, "+" on the red wire and "shield" on the shield.

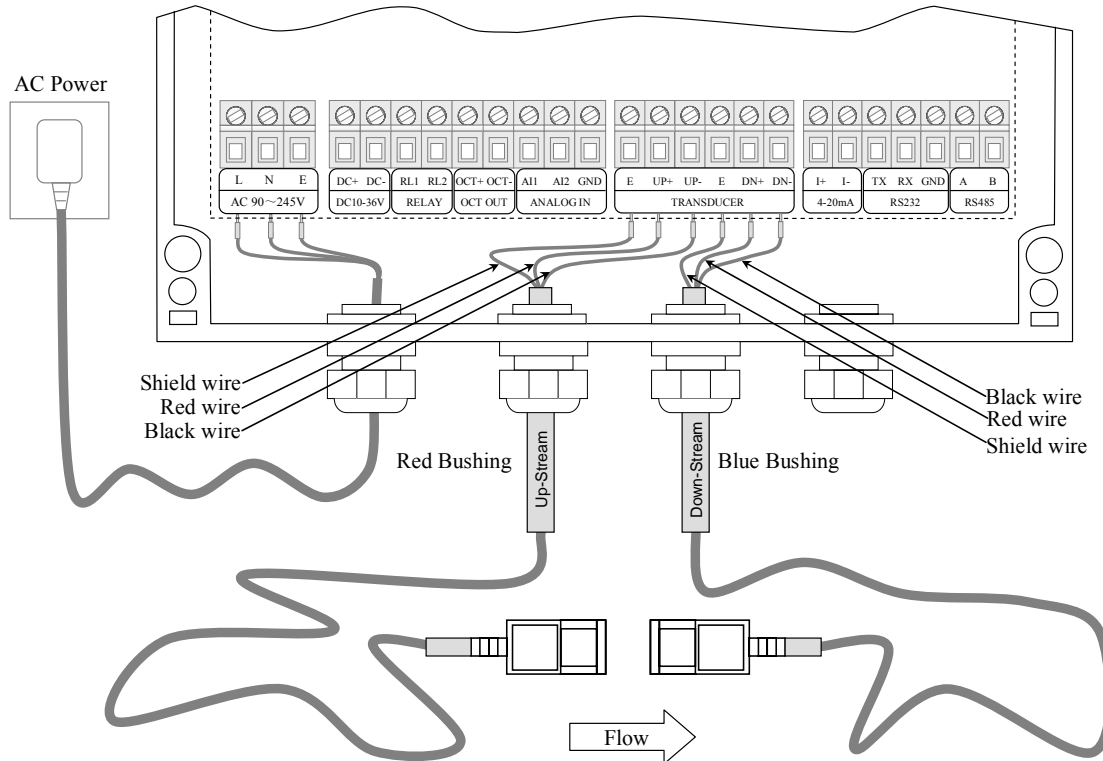

### Warning

Wire with power off.

Use either AC or DC power supply. Do not connect them both at the same time.

## 1.3. Powering On

As soon as the 205i is switched on, the self-diagnosis program will start to run. If any error is detected, an error code will display on the screen (Refer - Error Diagnoses). After that, the system will run automatically according to the last input parameters.

If the installation is accomplished when system is switched on, gain adjustment can be monitored in Window M01. After S1, S2, S3, S4 are displayed on the upper left corner of the screen, the system will activate the normal measurement condition automatically. It is indicated by code “\*R” on the upper right corner of the screen.

The system will default to the last window settings and automatically display them at next power on.

## 1.4. Keypad Functions

Follow these guidelines when using the Flow meter keypad (Refer to Keypad Figure):

0 ~ 9 And  $\odot$  input numbers.

$\leftarrow$  Backspace or delete characters to the left.

$\wedge$  And  $\vee$  Return to the last menu or to open the next menu. Acts as “+” and “-” functions when entering numbers.

$\text{Menu}$  Select a menu. Press this key first, then input two menu numbers to display the selected menu. For example, To Input a pipe outside diameter, press  $\text{Menu}$  1 1 keys, where “11” is the window ID to display the parameter for pipe outside diameter.

Press  $\text{Rate}$  keys into  $\text{Menu}$  0 2 Flow Rate / Positive Totalizer.

Press  $\text{Total}$  keys into  $\text{Menu}$  0 0 Flow Rate / Net Totalizer.

Press  $\text{Velocity}$  keys into  $\text{Menu}$  0 1 Flow Rate / Velocity.

Press  $\text{Fluid}$  keys into  $\text{Menu}$  2 0 Select Fluid Type.

Press  $\text{Signal}$  keys into  $\text{Menu}$  9 0 Signal Strength and Signal Quality.

Press  $\text{Response}$  keys into  $\text{Menu}$  0 8 System Error Codes.

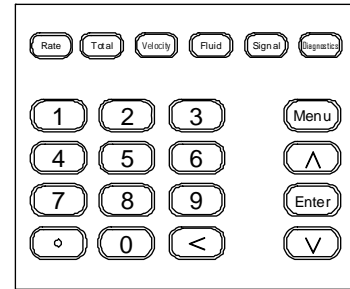

## 1.5. Keypad Operation

With all of the parameters entered, the instrument setup and measurement displays are subdivided or consolidated into more than 100 independent windows. The operator can input parameters, modify settings or display measurement results by “visiting” a specific window. These windows are arranged by 2-digit serial numbers (including “+” sign) from 00~99, then to +0, +1, etc. Each window serial number, or so-called window ID code, has a defined meaning. For example, Window M11 indicates the parameter input for pipe outside diameter, while Window M25 indicates the mounting spacing between the transducers, etc. (Refer – Windows Display Explanations).

The keypad shortcut to visit a specific window is to press the  $\text{Menu}$  key at any time, then input the 2-digit window ID code. For example, to input or check the pipe outside diameter, just press the  $\text{Menu}$  1 1 keys for window ID code 11.

Another method to visit a particular window is to press  $\wedge$   $\vee$  and  $\text{Enter}$  keys to scroll the screen. For example, if the current window ID code is 66, press  $\wedge$  key to enter Window M65, press the  $\wedge$  button again to enter Window M64; then, press the  $\vee$  key to back Window M65, and press the  $\vee$  key again to enter Window M66.

Example1: To enter a pipe outside diameter of 219.234, the procedure is as follows:

Press  $\text{Menu}$  1 1 keys to enter Window M11 (the numerical value displayed currently is a previous value). Now press  $\text{Enter}$  key. The symbol “>” and the flashing cursor are displayed at the left end of the second line on the Screen. The new value can be entered then...

$\text{2}$   $\text{1}$   $\text{9}$   $\odot$   $\text{2}$   $\text{3}$   $\text{4}$   $\text{Enter}$

Example2: If the pipe material is “Stainless Steel”, press keys  $\text{Menu}$  1 4 to enter Window M 14 first. Then press  $\text{Enter}$  key to modify the options. Now, select the “1. Stainless Steel” option by pressing  $\wedge$  and  $\vee$  keys, and then press  $\text{Enter}$  key to confirm

Pipe Outer Diameter  
>\_

the selection. It is possible to press the **1** key to change the selection and wait until “1. Stainless Steel” is displayed on the second line of the screen. Then press the **Enter** key to confirm.



Pipe Material [ 14  
>1. Stainless Steel

---

#### ATTENTION



Generally, press **Enter** key first if operator wants to enter “modify” condition. If the “modify” is still not possible even after pressing the **Enter** key, it means that system is locked by a password. To “Unlock” it, select “Unlock” in Window M47 and enter the original password. The keypad will not respond if the keypad is locked.

---

## 1.6. Flow Meter Window Descriptions

The Innova-Sonic 205i has the unique feature of windows processing for all operations.

These windows are assigned as follows:

- 00~09 Flow Totalizer Display: to display flow rate, positive total, negative total, net total, velocity, date & time, analog inputs for present flow, present operation and flow results today, etc.
- 10~29 Initial Parameter Setup: to enter pipe outside diameter, pipe wall thickness, fluid type, transducer type, transducer mounting and spacing, etc.
- 30~38 Flow Units Options: to select the flow unit, totalizer unit, measurement unit, turn totalizers on/off and reset totalizes, etc.
- 40~49 Setup options: Scaling factor, network IDN (Window M46), system lock (Window M47), etc.
- 50~89 Input and output setup: relay output setup, 4-20mA outputs, flow batch controller, LCD backlit option, date and time, low/high output frequency, alarm output, date totalizer, etc.
- 90~95 Diagnoses: Signal strength and signal quality (Window M90), TOM/TOS\*100 (Window M91), flow sound velocity (Window M92), total time and delta time (Window M93), Reynolds number and factor (Window M94), Data Interval (Window M95) etc.
- +0~+5 Appendix: power on/off time, total working hours, on/off times and a single-accuracy function calculator.

---

#### ATTENTION



The other windows are for hardware adjustment by the manufacturer.

---

## 2. Pipe Parameter Entry Shortcuts

For example, measuring the diameter of DN200, measuring medium is water, Material is carbon steel, No Liner, can be operated as follows:

### Step1. Pipe outside diameter:

Press keys to enter Window M11, and enter the pipe outside diameter, and then press the key.

Pipe Outer Diameter  
200 mm

### Step2. Pipe wall thickness

Press the key to enter Window M12, pipe wall thickness, and press the key.

Pipe Wall Thickness  
6 mm



### WARNING

The Wall Thickness needs to be 0.001mm for use with insertion sensors.

### Step3. Pipe material

Press the key to enter Window M14, press the key, move the or key to select pipe material, and press the key.

Pipe Material [14  
0. Carbon Steel

### Step4. Liner material parameters

(including thickness and sound velocity, if needed)

Press the key to enter Window M16, press the key, move the or key to select liner material, and press the key.

Liner Material [16  
0. None, No Liner

### Step5. Fluid type

Press the key to enter Window M20, press the key, move the or key to select fluid type, press the key.

Fluid Type [20  
0. Water

### Step6. Transducer type

(The transmitter is available for various transducer types)

Press the key to enter Window M23, press the key, move the or key to select transducer type, and press the key.

Transducer Type [23  
0. Standard

**NOTE**

The S, W, WH type sensors are all standard type.

**Step7. Transducer mounting methods**

Press the  $\downarrow$   $\text{2}$   $\text{4}$  key to enter Window M24, press the  $\text{Enter}$  key, move the  $\uparrow$  or  $\downarrow$  key to select transducer-mounting method, and press the  $\text{Enter}$  key.

Transducer Mounting  
0. V

**Step8. Adjust Transducer spacing**

Press the  $\downarrow$   $\text{2}$   $\text{5}$  key to enter Window M25, accurately install the transducer according to the displayed transducer mounting spacing and the selected mounting method (Refer to Installing the Transducers in this chapter).

Transducer Spacing  
159.86 mm

**Step9. Display measurement result**

Press the  $\text{Menu}$   $\text{0}$   $\text{1}$  keys to enter Window M01 to display measurement result.

Flow 0.1129 m<sup>3</sup>/h \* R  
Vel 1.0415 m/s

### 3. Measurement Site Selection

When selecting a measurement site, it is important to select an area where the fluid flow profile is fully developed to guarantee a highly accurate measurement. Use the following guidelines to select a proper installation site:

Choose a section of pipe that is always full of liquid, such as a vertical pipe with flow in the upward direction or a full horizontal pipe. Ensure enough straight pipe length at least equal to the figure shown below for the upstream and downstream transducers installation.

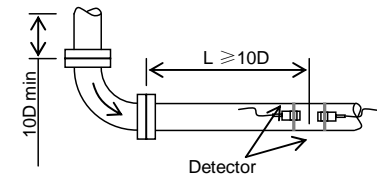
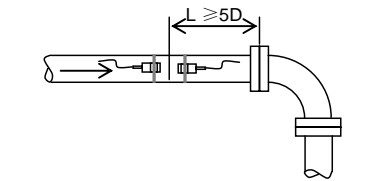
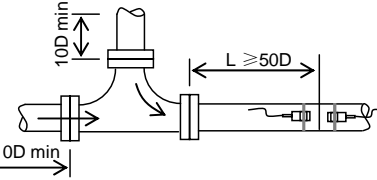
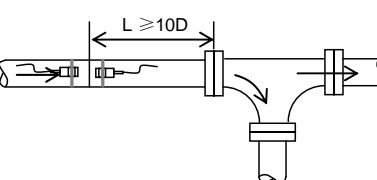
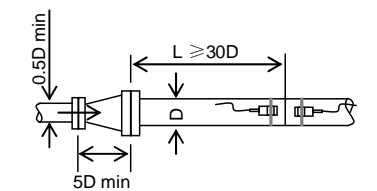
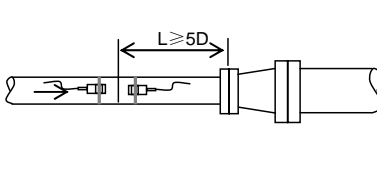
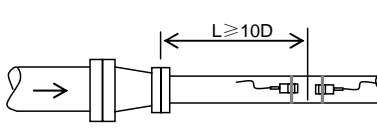
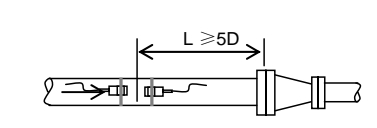
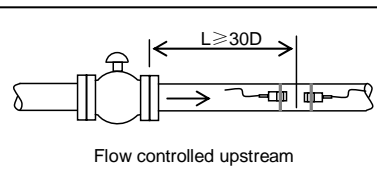
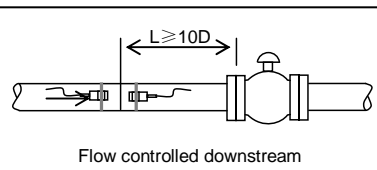
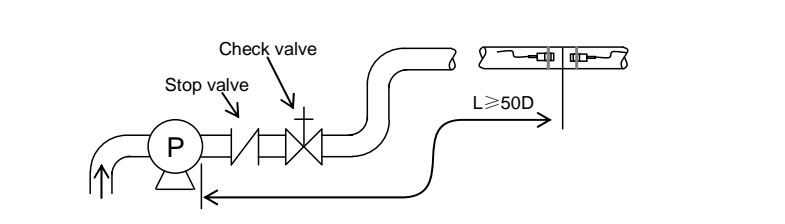
Name	Straight length of upstream piping	Straight length of downstream piping
90° bend		
Tee		
Diffuser		
Reduce		
Valve		
Pump		

Ensure that the pipe surface temperature at the measuring point is within the transducer temperature limits.

Consider the inside condition of the pipe carefully. If possible, select a section of pipe where the inside is free of excessive corrosion or scaling.

## 4. Transducer Installation

### 4.1. Installing the Transducers

Before installing the transducers, clean the pipe surface where the transducers are to be mounted. Remove any rust, scale or loose paint and make a smooth surface. Choose a section of sound conducting pipe for installing the transducers. Apply a wide band of sonic coupling compound down the center of the face of each transducer as well as on the pipe surface, and then attach the transducers to the pipe with the straps provided and tighten them securely.



---

**NOTE**

The two transducers should be mounted at the pipe's centerline on horizontal pipes. Make sure that the transducer mounting direction is parallel with the flow.

---

During the installation, there should be no air bubbles or particles between the transducer and the pipe wall. On horizontal pipes, the transducers should be mounted in the 3 o'clock and 9 o'clock positions of the pipe section in order to avoid any air bubbles inside the top portion of the pipe. (Refer to Transducer Mounting). If the transducers cannot be mounted horizontally symmetrically due to limitation of the local installation conditions, it may be necessary to mount the transducers at a location where there is a guarantee full pipe condition (the pipe is always full of liquid).

#### 4.1.1 Transducer spacing

After entering the required parameters, the spacing between the ENDS of the two transducers is considered as the standard transducer spacing (Refer to Top View on transducer mounting methods). Check the data displayed in Window M25 and space the transducers accordingly.

#### 4.1.2 Transducer Mounting Methods

Four transducer mounting methods are available. They are respectively: V method, Z method and N method. The V method is primarily used on small diameter pipes (DN100~400mm, 4"~16"). The Z method is used in applications where the V method cannot work due to poor signal or no signal detected. In addition, the Z method generally works better on larger diameter pipes (over DN300mm, 12") or cast iron pipes.

The N method is an uncommonly used method. It is used on smaller diameter pipes (below DN50mm, 2").

#### 4.1.3 V Method

The V method is considered as the standard method. It usually gives a more accurate reading and is used on pipe diameters ranging from 25mm to 400mm (1~16") approximately. Also, it is convenient to use, but still requires proper installation of the transducer, contact on the pipe at the pipe's centerline and equal spacing on either side of the centerline.

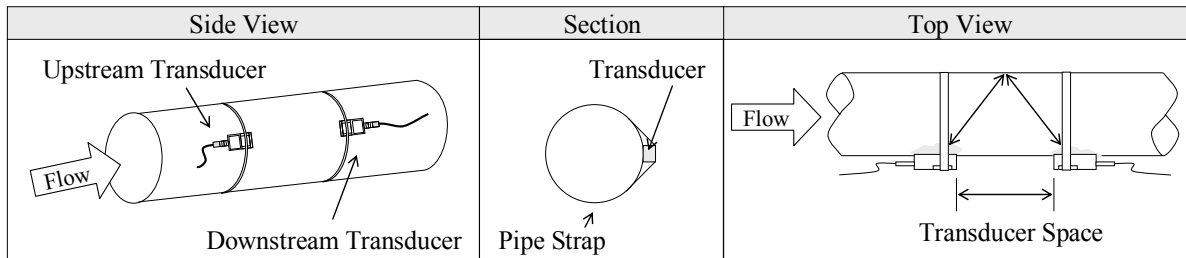

#### 4.1.4 Z Method

The signal transmitted in a Z method installation has less attenuation than a signal transmitted with the V method. This is because the Z method utilizes a directly transmitted (rather than reflected) signal which transverses the liquid only once.

The Z method is able to measure on pipe diameters ranging from 100mm to 3000mm (4"~120") approximately. Therefore, we recommend the Z method for pipe diameters over 300mm (12").

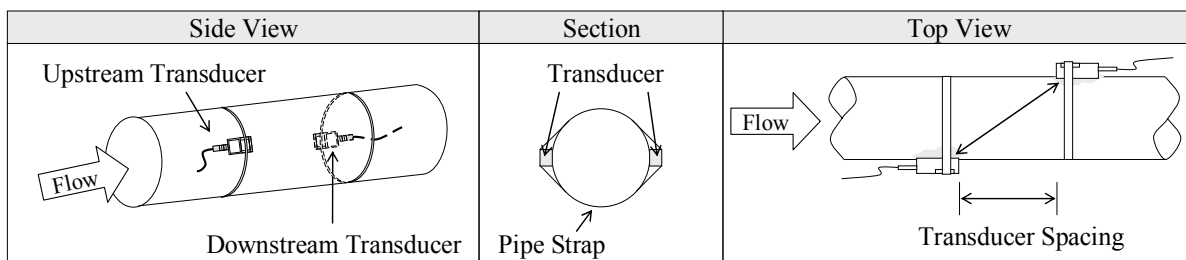

#### 4.1.5 N Method (not commonly used)

With the N method, the sound waves traverse the fluid three times and bounce twice times off the pipe walls. It is suitable for small pipe diameter measurement.

The measurement accuracy can be improved by extending the transit distance with the N method (uncommonly used).

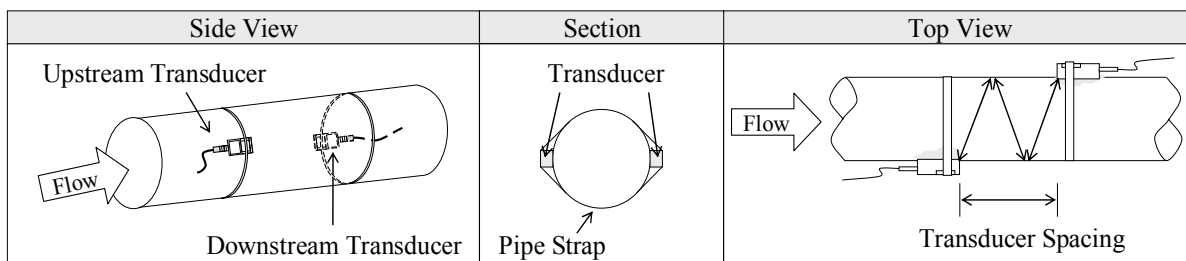

## 4.2. Transducer Mounting Inspection

Check to see if the transducer is installed properly and if there is an accurate and strong enough ultrasonic signal to ensure proper operation and high reliability of the transducer. It can be confirmed by checking the detected signal strength, total transit time, delta time as well as transit time ratio.

The "mounting" condition directly influences the flow value accuracy and system long-time running reliability. In most instances, only apply a wide bead of sonic coupling compound lengthwise on the face of the transducer and stick it to the outside pipe wall to get good measurement results. However, the following inspections still need to be carried out in order to ensure the high reliability of the measurement and long-term operation of the instrument.

## 4.2.1 Signal Strength

Signal strength (displayed in Window M90) indicates a detected strength of the signal both from upstream and downstream directions. The relevant signal strength is indicated by numbers from 00.0~99.9. 00.0 represents no signal detected while 99.9 represent maximum signal strength.

Normally, the stronger the signal strength detected, the longer the operation of the instrument reliably, as well as the more stable the measurement value obtained.

Adjust the transducer to the best position and check to ensure that enough sonic coupling compound is applied adequately during installation in order to obtain the maximum signal strength.

System normally requires signal strength over 60.0, which is detected from both upstream and downstream directions. If the signal strength detected is too low, the transducer installation position and the transducer mounting spacing should be re-adjusted and the pipe should be re-inspected. If necessary, change the mounting to the Z method.

## 4.2.2 Signal Quality (Q value)

Q value is short for Signal Quality (displayed in Window M90). It indicates the level of the signal detected. Q value is indicated by numbers from 00~99. 00 represents the minimum signal detected while 99 represent the maximum.

Normally, the transducer position should be adjusted repeatedly and coupling compound application should be checked frequently until the signal quality detected is as strong as possible.

## 4.2.3 Total Time and Delta Time

“Total Time and Delta Time”, which displays in Window M93, indicates the condition of the installation. The measurement calculations in the flow meter are based upon these two parameters. Therefore, when “Delta Time” fluctuates widely, the flow and velocities fluctuate accordingly. This means that the signal quality detected is too poor. It may be the result of poor pipe-installation conditions, inadequate transducer installation or incorrect parameter input.

Generally, “Delta Time” fluctuation should be less than  $\pm 20\%$ . Only when the pipe diameter is too small or velocity is too low can the fluctuation be wider.

## 4.2.4 Transit Time Ratio

Transit Time Ratio indicates if the transducer mounting spacing is accurate. The normal transit time ratio should be  $100 \pm 3$  if the installation is proper. Check it in Window M91.

---

### ATTENTION

If the transit time ratio is over  $100 \pm 3$ , it is necessary to check:



- (1) If the parameters (pipe outside diameter, wall thickness, pipe material, liner, etc.) have been entered correctly,
  - (2) If the transducer mounting spacing is accordance with the display in Window M25,
  - (3) If the transducer is mounted at the pipe's centerline.
  - (4) If the scale is too thick or the pipe mounting is distorted in shape, etc.
-



---

**WARNINGS**

- (1) Pipe parameters entered must be accurate; otherwise the flow meter will not work properly.
  - (2) During the installation, apply enough coupling compounds in order to stick the transducer onto the pipe wall. While checking the signal strength and Q value, move the transducer slowly around the mounting site until the strongest signal and maximum Q value can be obtained. Make sure that the larger the pipe diameter, the more the transducer should be moved.
  - (3) Check to be sure the mounting spacing is accordance with the display in Window M25 and the transducer is mounted at the pipe's centerline.
  - (4) Pay special attention to those pipes that are formed by steel rolls (pipe with seams), since such pipe is always irregular. If the signal strength is always displayed as 0.00, that means there is no signal detected. Thus, it is necessary to check that the parameters (including all the pipe parameters) have been entered accurately. Check to be sure the transducer mounting method has been selected properly, the pipe is not worn-out, and the liner is not too thick. Make sure there is indeed fluid in the pipe or the transducer is not very close to a valve or elbow, and there are not too many air bubbles in the fluid, etc. With the exception of these reasons, if there is still no signal detected, the measurement site has to be changed.
  - (5) Make sure that the flow meter is able to run properly with high reliability. The stronger the signal strength displayed, the higher the Q value reached, the longer the flow meter runs accurately, the higher the reliability of the flow rates displayed. If there is interference from ambient electromagnetic waves or the signal detected is too poor, the flow value displayed is not reliable; consequently, the capability for reliable operation is reduced.
  - (6) The transducer spacing in MENU 25 assumes perfect quality conditions. The flow meter was calibrated on a "perfect condition" flow calibration loop. It is necessary to check and perhaps adjust the transducer spacing in the real life application to ensure that the MENU 90 and MENU 91 diagnostic readings are within limits. MENU 90 should indicate Signal Strength UP and DOWN > 60 and the Quality value "Q" > 50. MENU 91, the Transit Time Ratio (TOM/TOS) must be 100 +/-3%.
-

## 5. Operating Instructions

### 5.1. System Normal Identification

Press the    keys. If the letter “\*R” displays on the screen, it indicates system normal.

- If the letter “E” is displayed, it indicates that the current loop output is over ranged by 120%. This refers to the settings in Window M57. Enter a larger value in Window M57, and the letter “E” will disappear. It can be ignored if no current loop output is used.
- If the letter “Q” is displayed, it indicates that the frequency output is over ranged by 120%, and this refers to the settings in Window M69. Increase the input value in Window M69, and the letter “Q” will disappear. It can be ignored if no frequency output is used.
- If the letter “H” is displayed, it indicates that the ultrasonic signal detected is poor. For more information, please refer to “Error Diagnoses”.
- If the letter “G” is displayed, it indicates that system is adjusting the signal gain prior to the measurement. Also, it means system normal. Only when the adjustment takes too long without stopping, can system be identified as abnormal.

Letter “I” indicates no signal is being detected. Check the transducer wiring connections are correct, the transducers are installed firmly, etc.

Letter “J” indicates a hardware defect exists. Normally, such defect is temporary; it could be eliminated by system reboot (power off and restart).

For further information, please refer to “Error Diagnoses”.

### 5.2. Zero Set Calibration

Once zero flow occurs, a zero point may indicate on each measuring instrument, i.e. as the measurement value reaches zero flow, it is indicated as zero. It is necessary to establish the true zero flow condition and program that set point into the instrument.

If the zero set point is not at true zero flow, a measurement difference may occur. The smaller the physical measurement capacity is, the larger the measurement difference from the zero point will exist. Only when zero point reduced to a definite degree, as compared with the physical measurement capacity, can the measuring difference from zero point be ignored.

For an ultrasonic flow meter, the measurement difference from zero point cannot be ignored at low flow. It is necessary to perform a zero set calibration to improve low flow measurement accuracy.

### 5.3. Scale Factor

Scale factor refers to the ratio between “actual value” and “reading value”. For example, when the measurement is 2.00, and it is indicated as 1.98 on the instrument, the scale factor reading is 2/1.98. This means that the best scale factor constant is 1.

However, it is difficult to keep the scale factor as “1” on the instrument especially in batch control operations. The difference is called “consistency”. High quality products always require high consistency.

The scale factor default is “1.XX” for each instrument prior to shipment from the factory. This corresponds to the calibration factors for the transducers. The reason is that the scale factors in the flow meter are only limited by two parameters, i.e. the crystal oscillation frequency and the transducer. It has no relation to any circuit

parameters.

During operation, there still exists possible difference in pipe parameters, etc. The “scale factor” may be necessary when used on different pipes. Thus, scale factor calibration is specially designed for calibrating the differences that result from application on different pipes. The scale factor entered must be one that results from actual calibration.

## 5.4. System Lock (Unlock)

System lock is intended to prevent operation error due to tampering by unauthorized personnel.

- Press the **Menu** **4** **7** **Enter** keys, move **▲** or **▼** key to select “Lock”, press the **Enter** key, enter a 1~4 numerically long password, and then press the **Enter** key to confirm.
- Unlock using the selected password only. Press **Menu** **4** **7** **Enter**, move **▲** or **▼** to select “Unlock”, press **Enter**, enter the correct password, then press **Enter** to confirm.
- Keep the password in mind or recorded in a safe place or the instrument cannot be used.

## 5.5. 4~20mA Current Loop Verification

Possessing a current loop output exceeding an accuracy of 0.1%, the flow meter is programmable and configurable with multiple output modules such as 4 ~20mA or 0~20mA. Select in Window M55. For details, please refer to “Windows Display Explanations”.

In Window M56, enter a 4mA flow value. Enter the 20mA flow value in Window M57. For example, if the flow range in a specific pipe is 0~1000m<sup>3</sup>/h, enter 0 in Window M56 and 1000 in Window M57. If the flow ranges from -1000~0~2000m<sup>3</sup>/h, configure the 20~4~20mA module by selecting Window M55 when flow direction is not an issue. Enter 1000 in Window M56 and 2000 in Window M57. When flow direction is an issue, module 0~4~20mA is available. When the flow direction displays as negative, the current output is in range of 0~4mA, whereas the 4~20mA is for the positive direction. The output module options are displayed in Window M55. Enter “-1000” in Window M56 and 2000 in Window M57.

Calibrating and testing the current loop is performed in Window M58. Complete the steps as follows:

Press **Menu** **5** **8** **Enter**, move **▲** or **▼** to display “0mA”, “4mA”, “8mA”, “16mA”, “20mA” readings, connect an ammeter to test the current loop output and calculate the difference. Calibrate it if the difference is within tolerance. Refer to Section 5.10 for Analog Output Calibration.

Check the present current loop output in Window M59 as it changes along with change in flow.

## 5.6. Frequency Output

The flow meter is provided with a frequency output transmitter function. The high or low frequency output displayed indicates the high or low flow rate reading. The user can reset the frequency output as well as flow rate per his requirements.

For example: if a pipe flow range is 0~3000m<sup>3</sup>/h, the relative frequency output required is 123~1000Hz, and the configuration is as follows:

In Window M68 (low limit frequency output flow value), input 0;

In Window M69 (high limit frequency output flow value), input 3000;

In Window M67 (low limit frequency), input 123;

There is no output circuit specially assigned to frequency output. It only can be transmitted through OCT, i.e. select Window M78 (item “13. FO”).

Typical OCT Output wiring diagram as below:

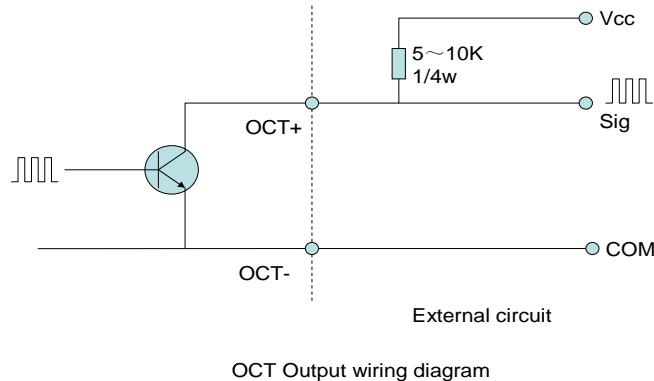

## 5.7. Totalizer Pulse Output

Each time the flow meter reaches a unit flow, it may generate a totalizer pulse output to a remote counter. To configure the unit flow, please refer to Windows M32 and M33.

The totalizer pulse output can be transmitted through OCT or a relay. So, it is necessary to configure OCT and the relay accordingly. (Please refer to Window M78 and M79).

For example, if it is necessary to transmit the positive totalizer pulse through a relay, and each pulse represents a flow of 0.1m<sup>3</sup>; the configuration is as follows:

In Window M33, select totalizer the flow unit “Cubic Meters (m<sup>3</sup>)”;

In Window M34, select the scale factor “x0.1”;

In Window M79, select “9. Positive totalizer pulse output”;



### Attention

Make sure the totalizer pulse does not transmit more than 1 pulse per second. If the totalizer is set to transmit faster than 1 pulse per second, you may shorten the life of the output, as well as skip some pulses.

## 5.8. Alarm Programming

The flowmeter has two programmable alarms: audible alarm and on off output alarm.

The audible alarm generates an internal beeper. Select the BEEPER trigger in Window M77.

The on-off output alarm is generated through OCT or transmission to an external circuit by opening or closing a relay. The on-off output signal is activated under the following conditions:

- (1) Signal not detected;
- (2) Poor signal detected;
- (3) The flow meter is not ready for normal measurement;
- (4) The flow is in the reverse direction (back flow).
- (5) The analog outputs exceed span by 120%.
- (6) The frequency output exceeds span by 120%.
- (7) The flow rate exceeds the ranges configured (Configure the flow ranges using the software alarm system. There are two software alarms: Alarm#1 and Alarm #2. The lower limit value for Alarm#1 is configured

in Window M73, and the upper limit value is configured in Window M74. As for Alarm#2, the lower limit value is in M75 and the upper one is in Window M76).

Example 1: To program the relay output alarm, activated when flow rate exceeds 300~1000m<sup>3</sup>/h:

- (1) In Window M73, input 300;
- (2) In Window M74, input 1000;
- (3) In Window M79, select item 6: “6. Alarm #1 limit exceed”.

Example 2: To program OCT output alarm signal, activated when flow rate exceeds 100~500m<sup>3</sup>/h; relay output alarm signal activated when flow rate exceeds 600~1000m<sup>3</sup>/h:

- (1) In Window M73, input 100;
- (2) In Window M74, input 500;
- (3) In Window M75, input 600;
- (4) In Window M76, input 1000;
- (5) In Window M78, select item 6: “6. Alarm #1”.
- (6) In Window M79, select item 7: “7. Alarm #2”.

## 5.9. Batch Controller

The batch controller is able to perform flow quantity control, or the batching of specific volumes to control events in product production or chemical dosing, etc. The internal batch controller in the flow meter is able to take the high or low end of analog input signals as an input, or through the keypad, to perform control functions. The output can be transmitted through OCT or a relay.

When taking analog inputs as control signals, input an analog output which is over 2mA through the analog input terminal to indicate the condition of “1”; current “0” indicates the condition of “0”.

In Window M78(OCT output ), M79(relay output) or M80(Flow Batch CTRL), select Item 8 “Batch controller” and the OCT or relay output will generate output signals.

Enter the batch value in Window M81. Start the batch controller after that. For details, please refer to “Windows Display Explanations”.

## 5.10. Analog Output Calibration



### Attention

Each flow meter has been calibrated strictly before leaving factory. It is unnecessary to carry out this step except when the current value (detected while calibrating the current loop) displayed in Window M58 is not identical with the actual output current value.

The hardware detect window must be activated prior to calibration. The procedure is as follows:

Press **Menu** **V** **0** **Enter** enter password “4213068”, then press **Enter** to activate the detect menu. With no effect to next power on, this window will close automatically as soon as the power is turned off.

Press **Menu** **V** **1** **Enter** to calibrate the current loop 4mA output. Use an ammeter to measure the current loop output current. At the same time, move **▲** or **▼** to adjust the displayed numbers. Watch the ammeter until it reads 4.00. Stop at this point, the 4mA has been calibrated.

Then, press **Enter** to calibrate the current loop 20mA output. The method is as same as in 4mA calibration.

The results are saved in EEPROM. Switching off the power supply will not lose these new settings.

## 5.11. Use of the Memory Card

### 5.11.1 Specifications

Memory: 2 GB (Standard)

Data collection update rate: User Selectable: 5 seconds to 13000 seconds (3.6 hours) . .

Data content: date and time, flow, velocity, cumulated flow, positive totalizer, negative totalizer, heat quantity

File system format: FAT16

File type: plain text file (.txt)

File number: maximum 512pcs

Filename format: yymmdd (yy - year, mm - month, dd - date)

SD Data format:

1= yy-mm-dd, hh:mm:ss

2= +3.845778E+01m<sup>3</sup>/h

3= +1.451074E+00m/s

4= -0000010E+0m<sup>3</sup>

5= +0000002E+0m<sup>3</sup>

6= -0000012E+0m<sup>3</sup>

7=+7.1429E-01KJ/s

8=+3.9721E+03KJ

9=+4.573242E+01

10=+4.338866E+01

It can save 120bytes of data each time. When the capacity of the SD card is full, the new data will override the earliest files automatically.

### 5.11.2 Install or Remove the SD card while the meter is powered on

If the operator desires to insert or remove the SD card with power on, the following operation is to be used: Shown as the picture below, move the switch to the “OFF” position. This switch activates the Memory Logging ONLY; it DOES NOT SECURE POWER TO THE FLOW METER. It is then safe to remove or install the SD Card. Once reinstalled, move the switch to the “ON” position, now the SD card can continue to log data.

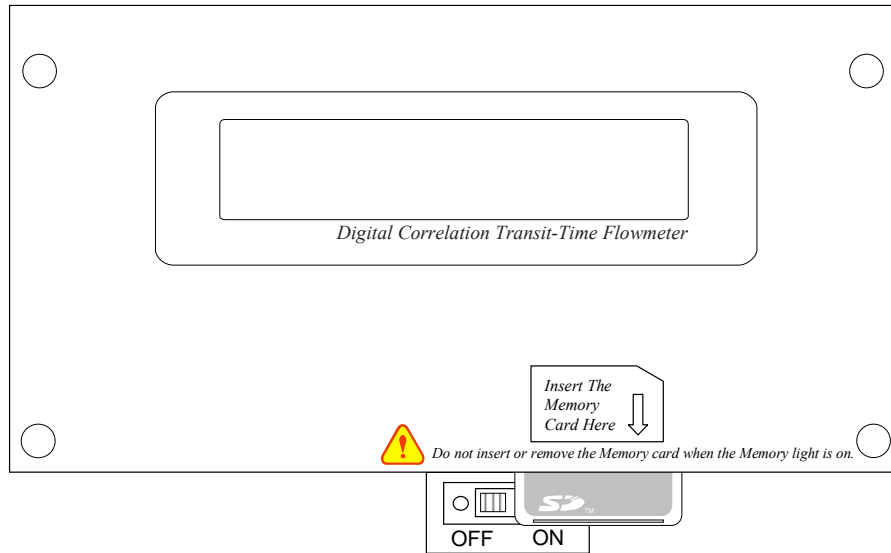

### 5.11.3 Reading the SD Data Externally

Remove the SD card from the flow meter. The operator may then use a PC carder reader to read the data in the card. On the PC the operator can save, edit and print the data in the SD card, and then recall and analyze the data. Care should be taken while working with the data on the SD card on a PC.



#### ATTENTION

Do not remove the SD card from the reader while actively working with the data. Data should be saved and stored in a separate location on the PC, and then processed from that file location. Processing the data directly from the SD card file location on the PC could result in lost or corrupt data if the SD card is removed while still being processed.

### 5.11.4 Reading the SD Data Internally with the Instrument powered ON

Open the cover of the meter; connect the flow meter to a PC via RS232. The operator can read and work with the data in the SD card with the “Converter” software provided with the flow meter:

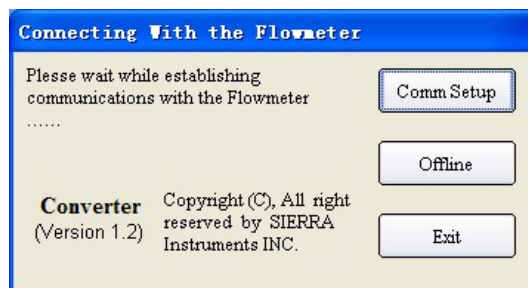

Click on “Comm Setup”, Set up communications port (Generally COM1) and baud rate:

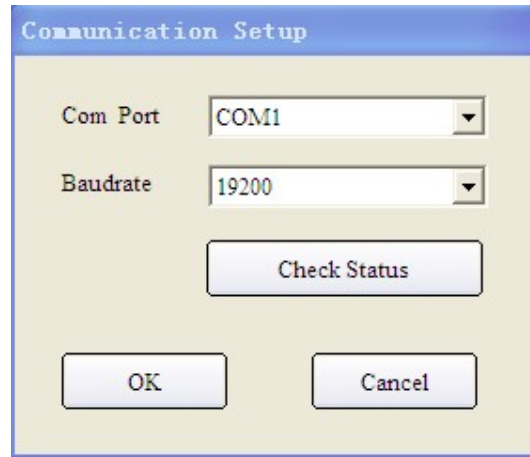

After connecting to the flow meter, Shown below (If not connected to flow meter, you can click on "Offline" button interface into the document conversion):

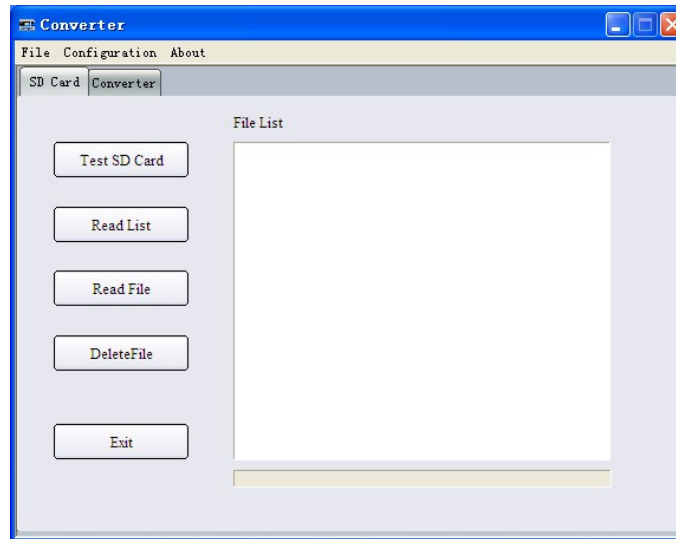

Due to the expanded memory (EMS) capacity of the flow meter being extremely small as compared with the SD memory card; the transfer speed is rather slow for some commands. So we suggest: it is better to read the SD data externally (remove the card from the flow meter to insert it into your PC).

- (1) Choose "Test SD card", if the LED is lit and there will be a message "The SD card is OK" displayed to show that SD card is working.
- (2) Click on "Read list" to return to the SD card catalog of all the documents.
- (3) Then click on "Read File" will be a reading of the progress of the document.

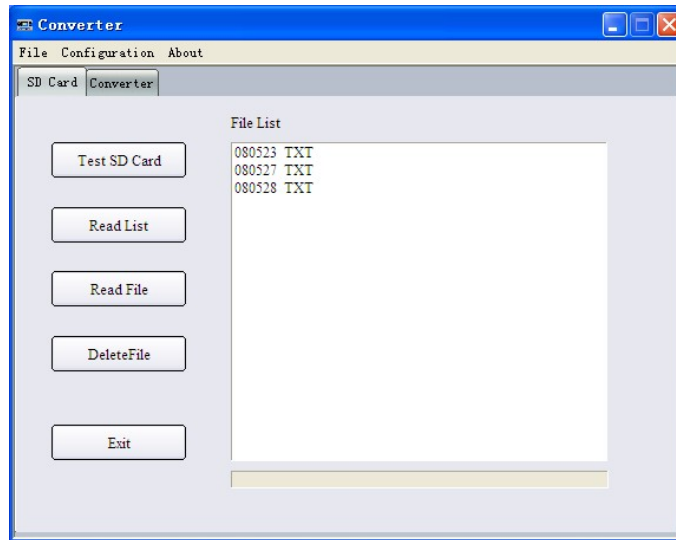

After the reading, a pop up display will show "The File has been read" and stored in the Converter.exe the root directory.

You may then delete the file from the SD card if necessary.

### 5.11.5 File converter tool

The files saved in the SD card are in text format (.TXT). If the operator desires to convert it to Excel format (.XLS), the file-conversion tool (Converter.EXE) may be found in the CD shipped with the flow meter. This program must be run in the WINDOWS operating system, the interface is as follows:

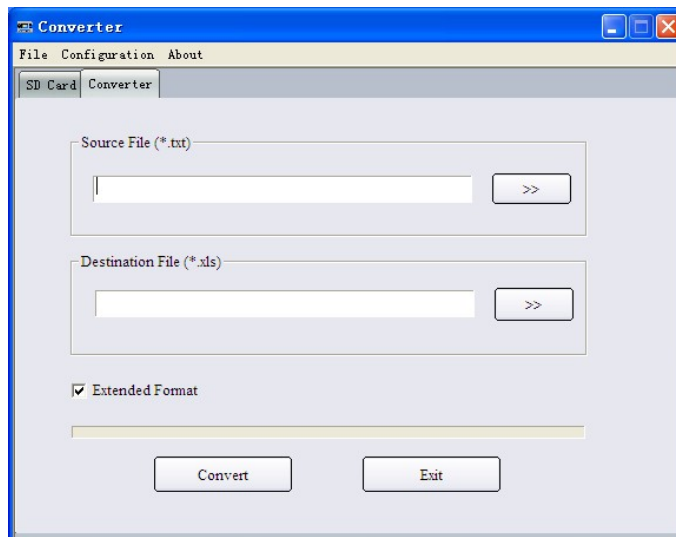

Select the file to be converted in "Source File (\*.txt)", enter the directory path and the filename in "Destination File (\*.xls)", then press "Convert". The conversion is completed.

## 5.12 Recover the Factory Default

If it is necessary to recover the factory default, Press MENU 37, then

Press  keys after the above-mentioned characters are displayed on the screen.

Generally, it is unnecessary to activate this function except during the initial installation.

## 5.13. ESN

We provide the flow meter with a unique electronic serial number to identify each flow meter for the convenience of the manufacturer and customers. The ESN, instrument types and versions are able to view in Window M61.

## 6. Windows Display Explanations

### 6.1. Windows Display Codes

<b>Flow Totalizer Display</b>	
00	Flow Rate/Net Totalizer
01	Flow Rate/Velocity
02	Flow Rate/POS Totalizer
03	Flow Rate/NEG Totalizer
04	Date Time/Flow Rate
05	Energy / Totalized Energy
06	Analog Input AI1, AI2
08	System Error Codes
09	Net Flow Today
<b>Initial Parameter setup</b>	
10	Pipe Outer Perimeter
11	Pipe Outer Diameter
12	Pipe Wall Thickness
13	Pipe Inner Diameter
14	Pipe Material
15	Pipe Sound Velocity
16	Liner Material
17	Liner Sound Velocity
18	Liner Thickness
20	Fluid Type
21	Fluid Sound Velocity
22	Fluid Viscosity
23	Transducer Type
24	Transducer Mounting
25	Transducer Spacing
26	Parameter Setups
27	Cross-sectional Area
28	Holding with Poor Sig
29	Empty Pipe Setup
<b>Flow Units Options</b>	
30	Measurement Units
31	Flow Rate Units
32	Totalizer Units
33	Totalizer Multiplier
34	Net Totalizer
35	POS Totalizer
36	NEG Totalizer
37	Totalizer Reset
38	Manual Totalizer
<b>Setup Options</b>	
40	Damping
41	Low Flow Cutoff Value
42	Set Zero
43	Reset Zero
44	Manual Zero Point

45	Scale Factor
46	Network identifying address code
47	System Lock
52	Energy Record
<b>Input and output setup</b>	
55	CL Mode Select
56	CL 4mA Output Value
57	CL 20mA Output Value
58	CL Check
59	CL Current Output
60	Date and Time
61	Software Version and ESN
62	RS232 Setup
63	AI1 Value Range
64	AI2 Value Range
66	AI3 Value Range
67	FO Frequency Range
68	Low FO Flow Rate
69	High FO Flow Rate
70	LCD Backlit Option
72	Working Timer
73	Alarm #1 Low Value
74	Alarm #1 High Value
75	Alarm #2 Low Value
76	Alarm #2 High Value
78	OCT Output Setup
79	Relay Output Setup
80	Flow Batch CTRL
81	Flow Batch Controller
82	Date Totalizer
83	Automatic Correction
<b>Energy Calculation Methods</b>	
84	Energy Units Select
85	Energy Time Select
86	Specific Heat Select
87	Energy Totalizer ON/OFF
88	Energy Multiplier
89	Reset Energy Totalizer
<b>Diagnoses</b>	
90	Signal Strength and Quality
91	TOM/TOS*100
92	Fluid Sound Velocity
93	Total Time and Delta
94	Reynolds Number and Factor
95	Data Interval

Appendix	
+0	Power ON/OFF time
+1	Total Working Hours
+2	Last Power Off Time
+3	Last Flow Rate
+4	ON/OFF Times
+5	Calculator

NOTE: The menu features from other manufacturers to retain.

## 6.2. Display explanation

While reading this section, please compare it with the instrument in order to improve your understanding.

Menu 000

Flow Rate / Net Totalizer

Display flow rate and net totalizer.

If the net totalizer has been turned off (refer to M34), the net totalizer value displayed is the total prior to its turn off.

```
Flow 0.1154 m3/h * R
NET 0x1m3
```

Menu 001

Flow Rate / Velocity

Display flow rate and velocity.

```
Flow 0.1129 m3/h * R
Vel 1.0415 m/s
```

Menu 002

Flow Rate / Positive Totalizer

Display flow rate and positive totalizer.

Select the positive totalizer units in Window M31.

If the positive totalizer has been turned off, the positive totalizer value displayed is the total prior to its turn off.

```
Flow 0.1129 m3/h * R
POS 0x1m3
```

Menu 003

Flow Rate / Negative Totalizer

Display flow rate and negative totalizer.

Select the negative totalizer value in Window M31.

If the negative totalizer has been turned off (refer to M36), the value displayed is the total prior to turn off.

```
Flow 0.1120 m3/h * R
NEG 0x1m3
```

Menu 004

Date Time / Flow Rate

Display the current date time and flow rate.

The time setting method is found in Window M60.

```
03-04-03 15:49:40 * R
Flow 0.1116 m3/h
```

Menu 005

Energy / Totalized Energy

Display Instantaneous Energy and Totalized Energy.

Instantaneous Energy Unit is determined by the unit selected in M84 and M85. Totalized Energy Unit is determined by the unit select in M84.

```
EFR 0.0000 GJ/h * R
E.T 0E+0 GJ
```

Menu 006

### Analog Input Value

Display Analog Input AI1, AI2 current value and corresponding temperature value.

AI 1= 4.0000:20.000  
AI 2= 8.0000:40.000

Menu 008

### System Error Codes

Display the working condition and the system error codes. More than one error code can occur at the same time.

The explanations of error codes and detailed resolution methods can be found in “Error Diagnoses”.

\* R - - - - -  
System Normal

Menu 009

### Net Flow Today

Display net total flow today.

Net Flow Today M09  
0.458748 m3

Menu 100

### Pipe Outer Perimeter

Enter the pipe outer perimeter. If the diameter of the pipe is known, enter it in window M11.

Pipe Outer Perimeter  
157 mm

Menu 101

### Pipe Outer Diameter

Enter the pipe outside diameter; the pipe outside diameter must range from 10mm to 6000mm.

Pipe Outer Diameter  
50 mm

Menu 102

### Pipe Wall Thickness

Enter the pipe wall thickness. If the pipe inside diameter is already known, skip this window and enter it in Window M13.

Pipe Wall Thickness  
4 mm

Menu 103

### Pipe Inner Diameter

Enter the pipe inside diameter. If the pipe outside diameter and pipe wall thickness has been entered, press  to skip this window.

Note: Enter either pipe wall thickness or pipe inside diameter.

Pipe Inner Diameter  
52 mm

Menu 1 4

### Pipe Material

Enter pipe material. The following options are available (by  $\uparrow$ ,  $\downarrow$  buttons or numerical keys):

0. Carbon Steel	1. Stainless Steel
2. Cast Iron	3. Ductile Iron
4. Copper	5. PVC
6. Aluminum	7. Asbestos
8. Fiber Glass-Epoxy	9. Other

Refer to item 9 “Other”; it is possible to enter other materials, which are not included in previous eight items. Once item 9 is selected, the relevant pipe sound velocity must be entered in Window M15.

Menu 1 5

### Pipe Sound Velocity

Enter pipe sound velocity. This function is only used when item 9 “Other” is selected in Window M14. Otherwise, this window cannot be viewed.

Menu 1 6

### Select the Liner Material

The following options are available:

0. None ,No Liner	1. Tar Epoxy
2. Rubber	3. Mortar
4. Polypropylene	5. Polystyryol
6. Polystyrene	7. Polyester
8. Polyethylene	9. Ebonite
10. Teflon	11. Other

Item 11 “Other” is available to enter other materials that are not included in previous ten items. Once the “Other” is selected, the relevant liner sound velocity must be entered in Window M17.

Menu 1 7

### Liner Sound Velocity

Enter liner sound velocity. This function is only used when Item 11 “Other” is selected in M16.

Menu 1 8

### Liner Thickness

Enter liner thickness. It only can be visited when a definite liner is selected in Window M16.

Pipe Material [ 14  
0. Carbon Steel

Pipe Sound Velocity  
2800 m/s

Liner Material [ 16  
0. None, No Liner

Liner Sound Velocity  
2270 m/s

Liner Thickness [ 18  
10 mm



Select Fluid Type

The following options are available:

0. Water	1. Sea Water
2. Kerosene	3. Gasoline
4. Fuel Oil	5. Crude Oil
6. Propane (-45°C)	7. Butane (0°C)
8. Other	9. Diesel Oil
10. Castor Oil	11. Peanut Oil
12. Gasoline #90	13. Gasoline #93
14. Alcohol	15. Water (125°C)

“Other” refers to any fluid. The relevant sound velocity must be entered in Window M21.

Fluid Type [20  
0. Water



Fluid Sound Velocity

Enter the fluid sound velocity. It can only be used when item “Other” is selected in Window M20, i.e. it is unnecessary to enter all the fluids listed in Window M20.

Fluid Sound Velocity  
1482.3 m/s



Fluid Viscosity

Enter fluid’s kinematics viscosity. It only can be used when item “Other” is selected in Window M20, i.e. it is unnecessary to enter all the fluids that listed in Window M20.

Fluid Viscosity [22  
1.0038 cST



Transducer type.

Please select “0.Standard”.

(The transmitter is available for various transducer types)

Press the key to enter Window M23, press the key, move the or key to select transducer type, and press the key.

Transducer Type [23  
0. Standard



#### NOTE

The S, W, WH type sensors are all standard type.

**Menu 2 4****Transducer Mounting**

Four mounting methods are available:

V( sound wave bounces 2 times)

Z(sound wave bounces once. The most commonly use method)

N (small pipe, sound wave bounces 3 times.)

**Transducer Mounting**  
0. V

**Menu 2 5**

**Transducer Spacing** (this value is calculated by the flow meter)

The operator must mount the transducer according to the transducer spacing displayed (be sure that the transducer spacing is measured precisely during installation). The system will display the data automatically after the pipe parameter had been entered.

**Transducer Spacing**  
148.666 mm

**Menu 2 6****Initial Parameter Setups and Save**

Load and save the parameters. 18 different sets of setup conditions/groups are available to load and save by three methods (i.e.you can load and save 18 different applications):

0. Entry to Save
1. Entry to Load
2. To Browse

Select “Entry to Save”, press **Enter**. An ID code and the original parameters are displayed in the window. Press UP or DOWN ARROW to move the ID code, then press the **Enter** key again to save the current parameter in the current ID room.

When selecting “Entry to Load”, press ENT, and the system will read and calculate the parameters automatically and display the transducer mounting spacing in Window M25.

**Parameter Setups**  
Entry to SAVE

**Menu 2 7****Cross-Sectional Area**

Display the cross-sectional area inside the pipe.

**Cross-sectional Area**  
31415.9 mm<sup>2</sup>

**Menu 2 8****Holding with Poor Sig**

Select “Yes” to hold last good flow signal displayed if the flow meter experiences a poor signal condition. This function will allow continued data calculation without interruption.

**Holding with Poor Sig**  
NO

Menu 2 9

### Empty Pipe Setup

This parameter is used to overcome the possible problems that usually show up when the pipe being measured is empty. Since signals can be transmitted through the pipe wall, the flow meter may still read a flow while measuring an empty pipe. To prevent this from happening, you can specify a value. When the signal quality falls below this value, the measurement stops automatically. If the flow meter is already able to stop measuring when the pipe is empty, a value in the range of 30 to 40 should also be entered in this window to ensure no measurement when the pipe is empty.

It should be understood that the instrument is NOT designed to function correctly on an empty pipe.

Empty Pipe Setup [29  
0

Menu 3 0

### Measurement Units Options

Select the measurement unit as follows:

- 0. Metric
- 1. English

Factory default is metric.

Measurement Units In  
0. Metric

Menu 3 1

### Flow Rate Units Options

The following flow rate units are available:

- 0. Cubic Meters (m3)
- 1. Liters (l)
- 2. USA Gallons (GAL)
- 3. Imperial Gallons (Imp gal)
- 4. Million Gallons (mg)
- 5. Cubic Feet (cf)
- 6. USA Barrels (US bbl)
- 7. Imperial Barrels (Imp bbl)
- 8. Oil Barrels (Oil bbl)

The following time units are available:

- /Day                    /Hour
- /Min                    /Sec

Factory default is Cubic Meters/hour.

Flow Rate Units [31  
m3/h

Menu 3 2

### Totalizer Units Options

Select totalizer units. The available unit options are as same as those found in Window M31. The user can select units as their required. Factory default is Cubic Meters.

Totalizer Units [32  
Cubic Meter (m3)



### Totalizer Multiplier Options

The totalizer multiplier acts as the function to increase the totalizer indicating range. Meanwhile, the totalizer multiplier can be applied to the positive totalizer, negative totalizer and net totalizer at the same time. The following options are available:

0. X0.001(1E-3)
1. X0.01
2. X0.1
3. X1
4. X10
5. X100
6. X1000
7. X10000(1E+4)

Factory default factor is x1.

Totalizer Multiplier  
0. x0.001(1E-3)



### ON/OFF Net Totalizer

On/off net totalizer. "ON" indicates the totalizer is turned on, while "OFF" indicates it is turned off. When it is turned off, the net totalizer displays in Window M00 will not change. Factory default is "ON".

Net Totalizer [34  
ON



### ON/OFF POS Totalizer

On/off positive totalizer. "ON" indicates the flow meter starts to totalize the value. When it is turned off, the positive totalizer displays in Window M02. Factory default is "ON".

POS Totalizer [35  
ON



### ON/OFF NEG Totalizer

ON/OFF negative totalizer. "ON" indicates the totalizer is turned on. When it is turned off, the negative totalizer displays in Window M03.

Factory default is "ON".

NEG Totalizer [36  
ON



### Totalizer Reset

Totalizer reset; all parameters are reset. Press ; move or arrow to select "YES" or "NO". After "YES" is selected, the following options are available:

None, All, NET, POS, NEG



If it is necessary to recover the factory default, press keys after the above-mentioned characters are displayed on the screen.

Generally, it is unnecessary to activate this function except during the initial installation.

Totalizer Reset? [37  
Selection

Menu 3 8

### Manual Totalizer

The manual totalizer is a separate totalizer. Press  to start, and press  to stop it. It is used for flow measurement and calculation.

Manual Totalizer [38]  
Press ENT When Ready

Menu 4 0

The damping function will stabilize the flow display. Essentially, it is a part of the signal filter. Enter a coefficient. Increasing the coefficient increases the stability. However, the measurement displayed may be slightly delayed due to over damping. Logging too long may result in no response to real-time fluctuation, especially when flow rate fluctuates wildly.

Therefore, damping should be kept at a minimum and increased just enough to reduce the fluctuation to an acceptable degree by 3 to 10 seconds.

The damping factor ranges from 0~999 seconds. 0 indicates no damping; 999 indicate the maximum damping. Usually a damping factor of 3 to 10 is recommended in applications.

Damping [40]  
10 sec

Menu 4 1

### Low Flow Cutoff Value

If the flow rate falls below the low flow cutoff value, the flow indication is driven to zero. This function can prevent the flow meter from reading flow after a pump is shut down but there is still liquid movement in the pipe, which will result in totalization error.

Generally, 0.03m/s is recommended to enter as the low flow cutoff point. The low flow cutoff value has no relation to the measurement results once the velocity increases over the low flow cutoff value

Low Flow Cutoff Val.  
0.01 m/s

Menu 4 2

### Set Zero

When fluid is in the static state, the displayed value is called “Zero Point”. When “Zero Point” is not at zero in the flow meter, the difference is going to be added into the actual flow values and measurement differences will occur in the flow meter.

Set zero must be carried out after the transducers are installed and the flow inside the pipe is in the absolute static state (no liquid movement in the pipe). Thus, the “Zero Point” resulting from different pipe mounting locations and parameters can be eliminated. The measuring accuracy at low flow is enhanced by doing this and flow offset is eliminated.

Press , wait for the processing instructions at the bottom right corner to reach 0.

Performing Set zero with existing flow may cause the flow to be displayed as “0”. If so, it can be recovered via Window M43.

Set Zer o [42  
Pr ess ENT to go

Menu 4 3

### Reset Zero

Select “YES”; reset “Zero Point” which was set by the user.

Reset Zer o [43  
NO

Menu 4 4

### Manual Zero Point

This method is not commonly used. It is only suitable for experienced operators to set zero under conditions when it is not preferable to use other methods. Enter the value manually to add to the measured value to obtain the actual value.

For example:

Actual measured value = 250 m<sup>3</sup>/H

Value Deviation = -10 m<sup>3</sup>/H

Flow Meter Display = 240 m<sup>3</sup>/H

Normally, set the value as “0”.

Manual Zer o Point [44  
0 m<sup>3</sup>/h

Menu 4 5

### Scale Factor

The scale factor is used to modify the measurement results. The user can enter a numerical value other than “1” according to calibration results.

Scale Factor [45  
1

Menu 4 6

### Network IDN

Input system identifying code, these numbers can be selected from 0~65535 except that 13 (0DH ENTER), 10 (0AH Newline), 42 (2AH \* ) and 38 (26H&) are reserved. System IDN is used to identify the flow meter to a network.

Network IDN [46  
88

Menu 4 7

### System Lock

Lock the instrument.

Once the system is locked, any modification to the system is prohibited, but the parameter is readable. "Unlock" using your designated password. The password is composed of 1 to 4 numbers.

System Lock [47  
\* \* \* \* Unlocked \* \* \* \*

Menu 5 2

### Energy Record

When set to "ON", SD Card begins to record energy data. When set to "OFF", SD Card stops recording energy data. The default setting is "OFF".

Energy Record ON/OFF  
OFF

Menu 5 5

### Current Loop Mode Select

CL Mode Select [55  
0. 4 - 20 mA

Select the current loop mode. The following options are available:

- |    |                   |  |
|----|-------------------|--|
| 0. | 4-20mA            | set up the output range from 4-20mA                                |
| 1. | 0-20mA            | set up the output range from 0-20mA                                |
| 2. | 0-20mA via RS232  | set up to be controlled by Serial Port                             |
| 3. | 4-20mA VS.Fluid   | set up the CL output 4-20mA corresponding sound velocity           |
| 4. | 20-4-20mA         | set up the CL output range from 20-4-20mA                          |
| 5. | 0-4-20mA          | set up the CL output range from 0-4-20mA                           |
| 6. | 20-0-20mA         | set up the CL output range from 20-0-20mA                          |
| 7. | 4-20mA vs. Vel    | set up the CL output range from 4-20mA corresponding flow velocity |
| 8. | 4-20mA vs. Energy | set up the CL output range from 4-20mA corresponding heat flow     |

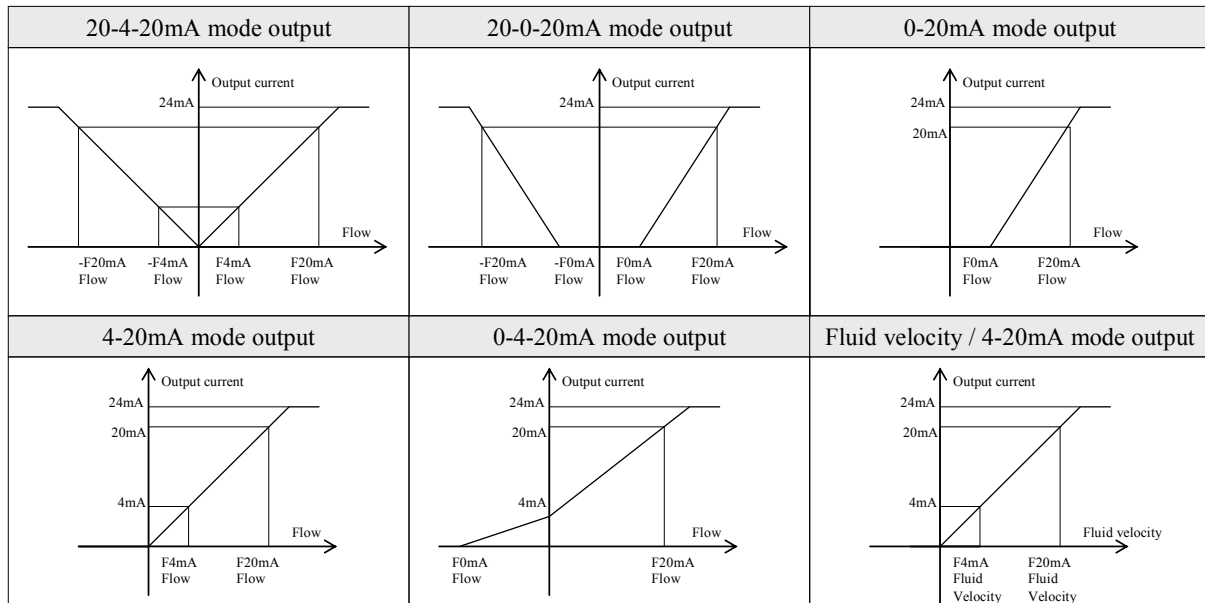

The Serial Port controls the output according to the command and parameter entered in the RS232 to output a definite current value through the current loop. The command formats are narrated in the command explanations to Serial Port controls. For example, if it is necessary to output a 6mA current through the current loop, it can be realized by setting Window M56 to the mode “0-20mA Via RS232” and giving a command as “AO6 (CR)”. This function is able to make the flow meter operate a control valve conveniently.

Other different current output characteristics are displayed in above figures. The user can select one of them according to his actual requirements.

In six graphs shown above, flow  $F_{0mA}$  or  $F_{4mA}$  indicates the value that user entered in Window M57; and flow  $F_{20mA}$  indicates the value that customer entered in Window M58. In the 4-20mA and 0-20mA modes,  $F_{0mA}$  (or  $F_{4mA}$ ) and  $F_{20mA}$  can be selected as a positive or negative flow value as long as the two values are not the same. As for modes 20-4-20mA and 20-0-20mA, the flow meter ignores the positive and negative value of the actual flow; therefore, both  $F_{0mA}$  (or  $F_{4mA}$ ) and  $F_{20mA}$  must be selected as positive flow values.

In mode 0-4-20mA,  $F_{0mA}$  must be select as a negative value and  $F_{20mA}$  as a positive value. Furthermore, in mode 4-20mA, the output current is indicated as velocity.



CL 4mA or 0mA Output Value

Set the CL output value according to the flow value at 4mA or 0mA. (4mA or 0mA are determined by the settings in Window M56). The flow unit’s options are as same as those in Window M31. Once “velocity 4-20mA” is selected in Window M56, the unit should be set as m/s.

When select “4-20mA vs Energy” the value unit in M55 is consistent with the energy unit displayed in M05. It is determined by the unit selection in M84 and M85.

When the energy unit changes ,need to reset the corresponding 4-20mA output value.

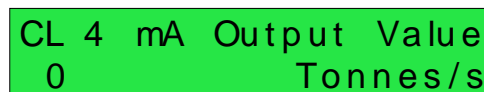
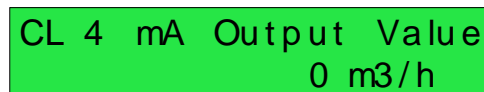

Menu 5 7

### 20mA Output Value

Set the CL output value according to the flow value at 20mA. The flow unit is the as same as that found in Window M31.

When select “4-20mA vs Energy” the value unit in M55 is consistent with the energy unit displayed in M05.It is determined by the unit selection in M84 and M85.

When the energy unit changes ,need to reset the corresponding 4-20mA output value.

CL 20mA Output Value  
14400 m3/h

CL 20mA Output Value  
0 Tonnes/s

Menu 5 8

### CL Check Verification

Check if the current loop has been calibrated before leaving the factory. Press **Enter** move **▲** or **▼** separately to display 0mA, 4mA till 24mA, and at the same time, check with an ammeter to verify that CL output terminals M31 and 32 agree with the displayed values. It is necessary to re-calibrate the CL if over the permitted tolerance. For more information, refer to “Analog Outputs Calibration”.

CL Checkup [58]  
Press ENT When Ready

Menu 5 9

### CL Current Output

Display CL current output. The display of 10.0000mA indicates that CL current output value is 10.0000mA. If the difference between displaying value and CL output value is too large, the current loop then needs to be re-calibrated accordingly.

CL Current Output [59]  
15.661 mA

Menu 6 0

### Date and Time Settings

Generally, it is unnecessary to modify date time as the system is provided with a highly reliable perpetual calendar chip.

The format for setting time setting is 24 hours. Press **Enter**, wait until “>” appears, the modification can be made.

YY- MM- DD HH:MM:SS  
03- 04- 04 10:05:04

Menu 6 1

### ESN

Display electronic serial number (ESN) of the instrument. This ESN is the only one assigned to each flow meter ready to leave the factory. The factory uses it for files setup and for management by the user.

Ultrasonic Flowmeter  
S/N=05071188

Menu 6 2

### COM Setup

The window used to set serial port. The Serial port for communications and other equipment. It connection with the equipment of its serial port set of parameters must match. Window the first choice of data that baud rate, 9600,19200,38400,56000,57600,115200 choice. The second option that in check, None.

Data length fixed to eight;

Stop bit for a fixed length;

Factory serial port parameters for the default “9600, 8, None, 1”.

RS- 232 Setup [62  
9600, None

Menu 6 3

### AI1 Value Range

In window 63 enter temperature value which 4mA and 20mA analog input represented. In this example window “10” represent 4mA corresponding temperature value, “100” represent 20mA corresponding temperature value.

AI 1 Value Range [63  
10 - 100

Menu 6 4

### AI2 Value Range

In window 64 enter temperature value which 4mA and 20mA analog input represented. See this window “10” represent 4mA corresponding value, “100” represent 20mA corresponding value.

AI 2 Value Range [64  
10 - 100

Menu 6 5

### AI3 Value Range

In window 65 enter temperature value which 4mA and 20mA analog input represented. See this window “10” represent 4mA corresponding value, “100” represent 20mA corresponding value.

AI 3 Value Range [65  
10 - 100

Menu 6 7

### Set FO Frequency Range

Set up low FO Frequency and high FO frequency range. The high FO must be higher than the low FO frequency. Ranges from 1-9999Hz. Factory default is 2000 Hz.

Note: The frequency output is transmitted through OCT Serial Port; therefore the OCT must be set to the frequency output mode.

FO Frequency Range  
1 - 5000

Menu **6** **8**

#### Low FO Flow Rate

Set up low FO flow rate, i.e. the corresponding flow value when output signal frequency is at the lowest

FO frequency. For example, when the low FO frequency is 1000Hz, low FO flow rate is 100m3/h (when the frequency output is 1000Hz, then the low flow at this moment measured by the flow meter is 100m3/h).

Low FO Flow Rate [68  
0 m3/h

Menu **6** **9**

#### High FO Flow Rate

Enter the high FO flow rate, i.e. the corresponding flow value when frequency output signal is at highest FO frequency.

High FO Flow Rate [69  
26550 m3/h

Menu **7** **0**

#### LCD Backlit Option

Select LCD backlit controls.

0. Always OFF, 1. Always ON, 2. Lighting For

“Always On” indicates that the backlight remains lit constantly; “Always Off” indicates that the backlight remains off constantly. Select “Time=”, then enter the desired backlighting time for “n” seconds; it indicates that after pressing the button, the backlighting will keep on for “n” seconds then turn off automatically. This function saves energy.

LCD Backlit Option  
0. Always ON

Menu **7** **2**

#### Working Timer

Display the totalized working hours of the flow meter since last reset. It is displayed by HH:MM:SS. If it is necessary to reset it, press **Enter**, and select “YES”.

Working Timer [72  
0000011:16:38

Menu **7** **3**

#### Alarm #1 Low Value

Enter the low alarm value. Both relevant alarms are turned on in Windows M78 and M79; any of the measured flow, which is lower than the low value, will activate the alarm in the OCT hardware or relay output signal.

Alarm #1 Low Value  
0 m3/h

Menu **7** **4**

#### Alarm #1 High Value

Enter the high alarm value. Both relevant alarms are turned on in Windows M78 and M79; any of the measured flow, which is higher than the high value, will activate the alarm in the OCT hardware or relay output signal.

Alarm #1 High Value  
14400 m3/h

## Menu 7 5

## Alarm #2 Low Value

Enter the alarm low value. Both relevant alarms are turned on in Windows M78 and M79; any measured flow, which is lower than the low value, will activate the alarm in the OCT hardware or relay output signal.

Alarm #2 Low Value  
0 m3/h

## Menu 7 6

## Alarm #2 High Value

Enter the alarm high value.

Alarm #2 High Value  
14400 m3/h

## Menu 7 8

## OCT Output Setup

The OCT output in the flow meter is a kind of isolated collector open circuit output with programmable open and close qualifications. The user can program the open and close functions under the following conditions: the system alarm signals are being activated or the totalizer pulse is being transmitted.

The frequency output signal is also transmitted from the OCT. When it functions as the frequency output, other functions are unavailable.

The following signal options are available:

0. No Signal	1. Poor Signal
2. Not Ready (No*R)	3. Reverse Flow
4. AO Over 100%	5. FO Over 120%
6. Alarm #1	7. Alarm #2
8. Batch Control	9. POS Int Pulse
10. NEG Int Pulse	11. NET Int Pulse
12. Energy Pulse	13. FO
14. FO via RS-232C	15. ON/OFF viaRS232
16. Fluid changed	17. Not Using

OCT Output Setup [78  
16. Fluid changed

## Menu 7 9

## Relay Output Setup

The relay output in the flow meter is programmable. The user can program the open and close functions under the following conditions: the system alarm signals are activated or the totalizer pulse is transmitting. The relay is single-pole and constant-on for external instrument controls. The following options are available:

0. No Signal	1. Poor Signal
2. Not Ready (No*R)	3. Reverse Flow
4. AO Over 100%	5. FO Over 120%
6. Alarm #1	7. Alarm #2
8. Batch control	9. POS Int Pulse
10. NEG Int Pulse	11. NET Int Pulse
12. Energy Pulse	13. ON/OFF via RS232
14. Fluid changed	15. Not Using

RELAY Output Setup  
8. Batch Control

## Menu 8 0

Flow Batch CTRL

Set the input trigger for the batch control function on the flow meter. The following options are available:

0.Key Input	1.AI1 Up Edge
2.AI1 Down Edge	3.AI2 Up Edge
4.AI2 Down Edge	5.AI3 Up Edge
6.AI3 Down Edge	7.AI4 Up Edge



Flow Batch Controller

The internal batch controller in the flow meter is able to control the input signals through keypad or analog input Serial Port. Output signals can be transmitted through OCT or relay.

The flow batch value can be modified in this window. The screen will enter the batch control display as soon as the modification completed.



Date Totalizer

The following options are available:

- 0. Day
- 1. Month
- 2. Year

In this window, it is possible to review the historical flow data totalizer for any day for the last 64 days, any month for last 64 months and any year for last 5 years. Press **Enter**, use the **▲** or **▼** to review totalizer in days, months and years. Left upper corner: "00-63" indicates the serial numbers;

In the middle: "03-04-05" indicates the date; Upper right corner: "G-H-I" indicates the working condition. If there is only "-----" displayed, it indicates the system was normal during that time period. If other characters displayed, please refer to the "Error Code and Resolutions".

For example, to display the flow total for July 18, 2000, the display "-----" at the upper right corner of the screen indicates that it was working properly the whole day. On the contrary, if "G" is displayed, it indicates that the instrument gain was adjusted at least once. Probably it was offline once on that day. If "H" is displayed, it indicates that poor signal was detected at least once. Also, it indicates that the operation was interrupted or problems occurred in the installation.

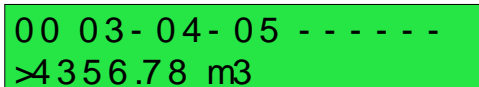
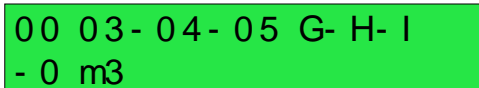
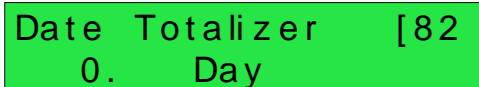
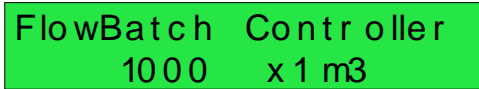
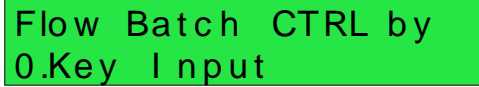

Menu 8 3

### Automatic Flow Correction

With the function of automatic flow correction, the flow lost in an offline session can be estimated and automatically adjusted. The estimate is based on the average value, which is obtained from flow rate before going offline and flow measured after going online the next time, multiplied times the time period that the meter was offline. Select “NO” to cancel this function.

Automatic Correction  
YES

Menu 8 4

### Energy Units Select

Select Energy Units: Giga Joule (GJ) and Kilocalories. The factory default unit is GJ.

The following options are available:

0. Giga Joule (GJ)
1. Kilocalorie (Kc)
2. MBtu
3. KJ
4. Btu
5. Tons(American tons)
6. Tonnes(metric tones)
7. kWh

Energy Units Select  
0. Giga Joule (GJ)

Menu 8 5

### Energy Time Unit Select

The following four units are available:

0. /s
1. /m
2. /h
3. /d

(Select with  $\uparrow$ 、 $\downarrow$ )

Energy time Select  
0. /s

Menu 8 6

### Specific Heat Select

Select the following 2 kinds of specific heat value:

0. Standard Specific Heat
1. Fixed Specific Heat

Generally specific heat water is 0.0041868GJ/M3□

Specific Heat Select  
0. Standard

Menu 8 7

### Energy Totalizer Switch

Select “ON” represent to open Energy Totalizer  
Select “OFF” represent to close Energy Totalizer

Energy Totalizer  
ON

Menu 8 8

### Energy Multiplier

Select Energy Multiplier range:  $10^{-4}$ ~ $10^6$  (E-4~E6)

Energy Multiplier [88  
4. x1 (E0)

Menu 8 9

### Reset Energy Totalizer

Select “YES” to reset Energy Totalizer value.

Reset Energy Total  
NO

Menu 9 0

Signal Strength and Signal Quality Display the measured signal strength and signal quality Q value upstream and downstream.

Signal strength is indicated from 00.0 ~ 99.9. A reading of 00.0 indicates no signal detected, while 99.9 indicates maximum signal strength. Normally the signal strength should be  $\geq 60.0$ . Signal quality Q is indicated by 00 ~ 99. Therefore, 00 indicates the poorest signal while 99 indicates the best signal. Normally, signal quality Q value should be better than 50.

Strength+Quality [90  
UP:00.0 DN:00.0 Q=00

Menu 9 1

### TOM/TOS\*100

Display the ratio between the actual measured transmit time and the calculated transmit time according to customer's requirement. Normally the ratio should be  $100 \pm 3\%$ . If the difference is too large, the user should check that the parameters are entered correctly, especially the sound velocity of the fluid and the installation of the transducers. This data is of no use before the system is ready.

TOM/TOS\* 100 [91  
0.0000%

Menu 9 2

### Fluid Sound Velocity

Display the measured fluid sound velocity. Normally this value should be approximately equal to the entered value in Window M21. If the difference is too large, it probably results from an incorrect value entered in Window M21 or improper installation of the transducers.

Fluid Sound Velocity  
1443.4 m/s

Menu 9 3

### Total Time and Delta Time

Display the measured ultrasonic average time (unit: nS) and delta time of the upstream and downstream (unit: nS) time. The velocity calculation in the flow meter is based on the two readings. The delta time is the best indication that the instrument is running steadily. Normally the fluctuation in the ratio of the delta time should be lower than 20%. If it is not, it is necessary to check if the transducers are installed properly or if the parameters have been entered correctly.

Totl Time, Delta Time  
8.9149uS, - 171.09nS

Menu 9 4

### Reynolds Number and Factor

Display the Reynolds number that is calculated by the flow meter and the factor that is set currently by the flow meter. Normally this scaling factor is the average of the line and surface velocity factor inside the pipe.

```
Reynolds Number [94
0.0000          1.0000
```

Menu 9 5

### Data Interval

Input the data collection time interval in this menu. Time is in seconds. The interval can be selected in the range of 5~13000 seconds (3.6 hours). Press **Enter**, the display shows ">" on the second line, input the required data collection interval, and then press **Enter**. The data collection interval is set. The factory default is 5 seconds.

```
DATA interval [95
300           S
```

Menu ^ 0

### Power ON/OFF Time

To view the power on/off time and flow rate for the last 64 update times to obtain the offline time period and the corresponding flow rate. Enter the window, press **Enter** to display the last update before the last 64 times of on/off time and flow rate values. "ON" on right hand indicates that time power is on; "00" on the upper left corner indicates "00-07-18 12:40:12" the date time; flow rate is displayed in the lower right corner.

```
ON/OFF Time      [+0
Press ENT When Ready
```

```
00- 07 18      12:40:12
* ON 123.65 m3/h
```

Menu ^ 1

### Total Working Hours

With this function, it is possible to view the total working hours since the flow meter left the factory. The figure on the right indicates that the total working hours since the flow meter left the factory is 1107 hours 1 minute 41 seconds.

```
Total Wbr k Hours [+1
00001107:01:41
```

Menu ^ 2

### Last Power Off Time

Display the last power off time.

```
Last Power Off Time
03- 04- 04      11:33:02
```

Menu ^ 3

### Last Flow Rate

Displays the last flow rate.

```
Last Flow Rate      [+3
100.43             m3/h
```

Menu ^ 4

### Total ON/OFF Times











Display total on/off times since the flow meter left the factory.

```
ON/OFF Times       [+4
40
```



### Calculator

This window works as a calculator with an internal calculation function. To use the calculator, enter the first parameter X, select a calculating operator; if there is a second parameter, enter it as parameter Y, then combine the calculation results into parameter X. For example:

To calculate 1+2, then it is necessary to press     , use  or  to select “+”, press    to confirm. This calculator is also provided with a register function.

Note: Using the calculator while the system is running will not influence the measurement.

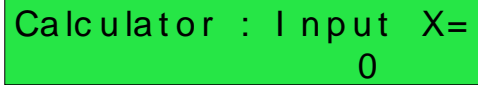

Calculator : Input X=  
0

## 7. Error Diagnoses

The ultrasonic flow meter has advanced self-diagnostics functions and displays any errors in the upper right corner of the LCD via definite codes in a date/time order. Hardware error diagnostics are usually performed upon each power on. Some errors can be detected during normal operation. Undetectable errors caused by incorrect settings and unsuitable measurement conditions can be displayed accordingly. This function helps to detect the errors and determine causes quickly; thus, problems can be solved in a timely manner according to the solutions listed in the following tables.

Errors displayed in the flow meter are divided into two categories:

Table 1 is for errors displayed during self-diagnostics upon power on. “\* F” may be displayed on the upper left corner of the screen after entering the measuring mode. When this occurs, it is necessary to power on for self-diagnostics once again to detect and solve possible errors using the table below. If a problem still exists, please contact the factory or the factory’s local representative for assistance.

Table 2 applies when errors caused by incorrect settings and signals are detected and are announced by error codes displayed in Window M08.

### 7.1. Table 1. Self-diagnoses and Error Solutions (upon power on)

LCD Display	Cause	Solution
Rom Parity Error	System ROM illegal or error	Contact the factory
Stored Data Error	System stored data block error	Power on again or contact the factory
SCPU Fatal Error	SCPU circuit fatal error	Power on again or contact the factory
Timer Slow Error Timer Fast Error	System clock error	Contact the factory
CPU or IRQ Error	CPU or IRQ problem	Power on again
System RAM Error	System RAM questionable	Power on again or contact the factory
Time or Bat Error	System date time chip error	Power on again or contact the factory
No Display, Erratic or Abnormal Operation	Bad wiring connection	Check wiring connections
Stroke Key - No Response	Keypad locked or bad plug connection	Enter the unlock password if the keypad is locked

## 7.2. Table 2. Error codes and solutions (during operation)

Code	M08 Display	Cause	Solution
*R	System Normal	System normal	No errors
*J	SCPU Fatal Error	Hardware defect	Contact the factory
*I	Signal Not Detected	Signal not detected.	Attach transducer to the pipe and tighten it securely. Apply a plenty of coupling compound on transducer and pipe wall.
		Spacing is not correct between the transducers or not enough coupling compound applied to face of transducers.	Remove any rust, scale, or loose paint from the pipe surface. Clean it with a file.
		Transducers installed improperly.	Check the initial parameter settings.
		Scale is too thick.	Remove the scale or change the scaled pipe section. Normally, it is possible to change a measurement location. The instrument may run properly at a new site with less scale.
		New pipe liner.	Wait until liners solidified and saturated.
*H	Low Signal Strength	Low signal strength. Cause refers to above-mentioned reasons.	Solution refers to above-mentioned solutions.
*H	Poor Signal Quality	Poor signal quality All reasons are included in the above-mentioned causes.	Solution refers to above-mentioned solutions.
*E	Current Loop over 20mA (No influence normally. Ignore it if no current output is being used.)	4-20mA current loop over 120%. Improper settings to current loop output.	Check settings (refer to Window M56) and confirm if actual flow is too high.
*Q	Frequency output over set value No influence normally. Ignore it if no frequency output is being used.	Frequency output over 120%. Improper settings to frequency output or actual flow are too high.	Check settings (refer to Window M66-M69) and confirm if the actual flow is too high.
*F	Refer to Table 1.	Error in self-diagnoses during power on.	Power on again; resolve it by the method listed in Table 1. If it is still a problem, contact the factory.
		Permanent hardware error.	Contact the factory.
*G	Adjusting Gain>S1 Adjusting Gain>S2 Adjusting Gain>S3 Adjusting Gain>S4 (Display in Windows M00,M01,M02,M03)	Adjusting gain for normal measurement. Stop in S1 or S2 and only switch between S1 and S2 indicates a poor waveform or low signal strength. All reasons may be included in above-mentioned items.	
*K	Pipe Empty. Set in Window M29	No fluid in pipe or settings incorrect.	Once fluid is detected in the pipe, set 0 in Window M29.

### 7.3. Frequently Asked Questions and Answers

Question: New pipe, high quality material, and all installation requirements met: why still no signal detected?

Answer: Check pipe parameter settings, installation method and wiring connections. Confirm if the coupling compound is applied adequately, the pipe is full of liquid, transducer spacing agrees with the screen readings and the transducers are installed in the right direction.

Question: Old pipe with heavy scale inside, no signal or poor signal detected: how can it be resolved?

Answer: Check if the pipe is full of fluid. Try the Z method for transducer installation (If the pipe is too close to a wall, or it is necessary to install the transducers on a vertical or inclined pipe with flow upwards instead of on a horizontal pipe).

Carefully select a good pipe section and fully clean it, apply a wide band of coupling compound on each transducer face (bottom) and install the transducer properly.

Slowly and slightly move each transducer with respect to each other around the installation point until the maximum signal is detected. Be careful that the new installation location is free of scale inside the pipe and that the pipe is concentric (not distorted) so that the sound waves do not bounce outside of the proposed area.

For pipe with thick scale inside or outside, try to clean the scale off, if it is accessible from the inside. (Note: Sometimes this method might not work and sound wave transmission is not possible because of the a layer of scale between the transducers and pipe inside wall).

Question: Why is there no CL (current loop) output?

Answer: Check if the desired current output mode is set in Window M55. See if the CL is powered off by “CL Off” settings.

Open the electronics enclosure to inspect the hardware circuit. Check to see if the short-circuit terminal near terminal 3 is in place between 1-2, i.e. Direct Output Mode(at location 2-3, set CL output as Transmitter Mode with external power supply).

Question: Why is the CL output abnormal?

Answer: Check to see if the desired current output mode is set in Window M55.

Check to see if the maximum and minimum current values are set properly in Windows M56 and M57.

Re-calibrate CL and verify it in Window M49.

Question: Why is the flow rate still displayed as zero while there is fluid obviously inside the pipe and a symbol of “R” displayed on the screen?

Answer: Check to see if “Set Zero” was carried out with fluid flowing inside the pipe(Refer to Window M42). If it is confirmed, recover the factory default in Window M43.

Question: With a poor measurement site environment in the plant and the voltage and power supplies fluctuating widely, is the instrument really able to keep running 24 hours a day repeatedly without stopping and last for several years under such conditions?

Answer: The Innova-Sonic 205i is designed to work with high reliability under such conditions. It is provided with an intelligent signal conditioning circuit and internal correction circuitry. It will work under strong interference conditions and is able to adjust itself with strong or weak sound waves. It will work in a wide band of voltage: 90-245VAC or 10V~36VDC voltage.

## 8. Product Overview

### 8.1. Introduction

The Innova-Sonic 205i is a state-of-the-art universal transit-time flow meter designed using SLSI technology and low voltage broadband pulse transmission. While principally designed for clean liquid applications, the instrument is tolerant of liquids with small amounts of air bubbles or suspended solids found in most industrial environments.

### 8.2. Features of Innova-Sonic 205i

With distinctive features such as high precision, high reliability, high capability and low cost, the flow meter features other advantages:

- Low consumption power, high reliability, anti-jamming and outstanding applicability.
- Clear, user-friendly menu selections make flow meter simple and convenient to use.
- U.S., British and Metric measurement units are available. Meanwhile, almost all-universal measurement units worldwide may be selected to meet customer's requirements.
- Daily, monthly and yearly totalized flow: Totalized flow for the last 64 days and months as well as for the last 5 years are may be viewed.
- Power on/off function: allows the viewing of time and flow rate as power is switched on and off 64 times. Also, the flow meter has manual or automatic amendment during offline sessions.
- Self-contained signal output, including relay, open collector, frequency and 4~20mA current loop analog outputs, etc.
- Parallel operation of positive, negative and net flow totalizes with scale factor (span) and 7 digit display, while the output of totalize pulse and frequency output are transmitted via relay and open collector.
- Internally configured batch controller makes batch control convenient.

### 8.3. Theory of Operation

When the ultrasonic signal is transmitted through the flowing liquid, there will be a difference between the upstream and downstream transit time (travel time or time of flight), which is proportional to flow velocity, according to the formula below.

$$V = \frac{MD}{\sin 2\theta} \times \frac{\Delta T}{T_{up} \bullet T_{down}}$$

Remarks:

- $V$  Medium Velocity  
 $M$  Ultrasonic frequency of reflection  
 $D$  Pipe Diameter  
 $\theta$  The angle between the ultrasonic signal and the flow  
 $T_{up}$  Transit time in the forward direction  
 $T_{down}$  Transit time in the reverse direction

$$\Delta T = T_{up} - T_{down}$$

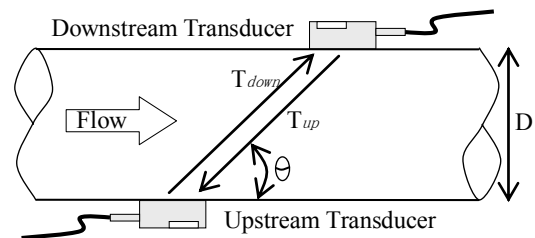

## 8.4. Applications

Water, sewage (with low particle content) and seawater

Water supply and drainage water

Power plants (nuclear power plant, thermal and hydropower plants), heat energy, boiler feed water and energy management system

Metallurgy and mining applications (cooling water and acid recovery, for example)

Petroleum and chemicals

Food, beverage and pharmaceutical

Marine operation and maintenance

Energy economy supervision and water conservation management

Pulp and paper

Pipeline leak detection

Regular inspection, tracking and collection

Energy measuring and balance

Network monitoring systems and energy/flow computer management

## 8.5. Specifications

### Performance Specifications

**Flow Range:**  
0 to +/- 40 ft/s (0 to +/- 12 m/s)

**Accuracy:**  
+/- 0.5% of reading

**Repeatability:**  
+/- 0.15% of reading

**Pipe Size:**  
1 in to 200 in (25mm to 5000mm)

### Operating Specifications

**Output:**  
Analog: 0/4 to 20mA (max load 750 Ω)  
Pulse output: 0 to 9999Hz, OCT, (min. and max. frequency is adjustable)  
Relay output: SPST, max 1Hz, (1A@125VAC or 2A @ 30VDC)  
Digital output: RS232, RS485

**Power Supply:** 90 to 250 VAC, 48 to 63 Hz and 10 to 36 VDC (both are available on each unit)

**Keypad:** 16 (4x4) key with push buttons

**Display:** 40 character, 2 line (20x2) lattice alphanumeric, backlit LCD

**Temperature:** Transmitter: -40°F to 140°F (-40°C to 60°C)  
Clamp-on transducer: -40°F to 176°F (-40°C to 80°C)  
Insertion transducer: -40°F to 176°F (-40°C to 80°C)  
Clamp-on high-temperature transducer: -40°F to 300°F (-40°C to 150°C)  
Insertion high-temperature transducer: -40°F to 300°F (-40°C to 150°C)

**Insertion Transducer Pressure:**  
Max operating pressure, 300 psig (20 barg)

**Humidity:** Up to 99% RH, (non-condensing).

### Physical Specifications

**Transmitter:** NEMA 4X (IP65), die-cast aluminum

**Transducer:** Encapsulated design standard/maximum cable length: 30ft/1000ft (9m/305m), IP 67

**Weight:** Transmitter: Approximately 4.7 lb. (2.15kg)

### Typical Clamp-On Installation



### Transmitter Dimensional Specifications

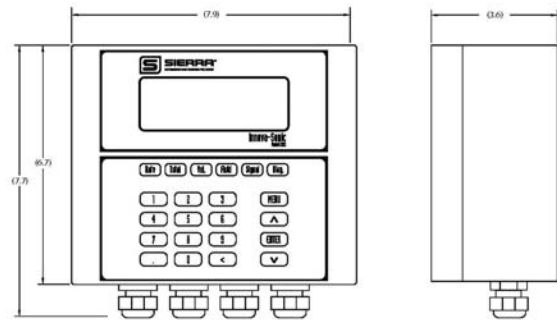

### Clamp-on Transducer Dimensional Specifications

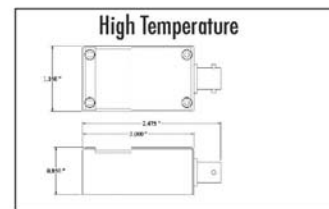
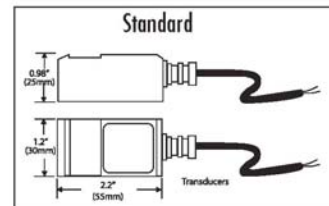

### Typical Insertion Installation



Standard Insertion Transducer

Small (3/4") Insertion Transducer

**Suitable Locations**

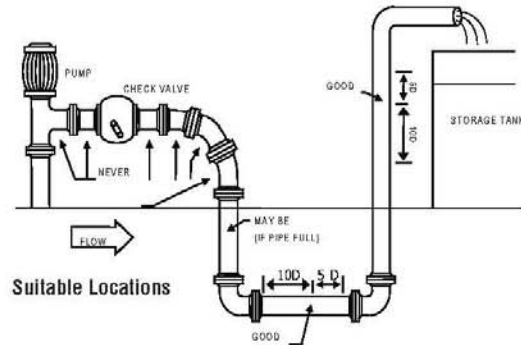
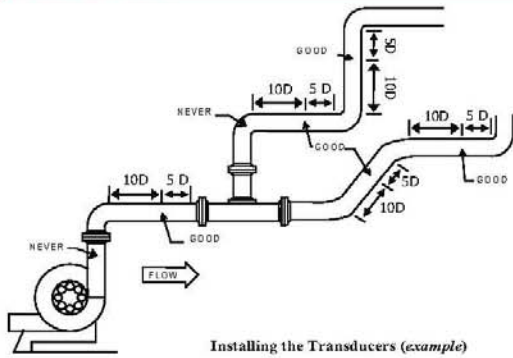

**Transducer Spacing Requirements**

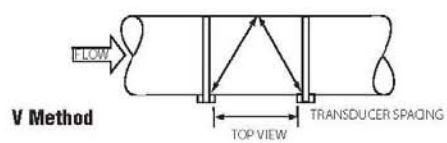
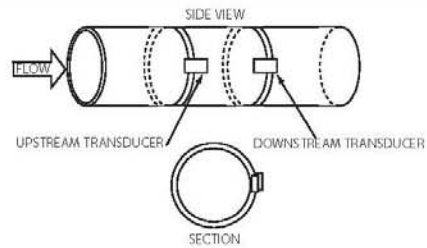
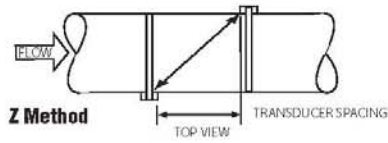
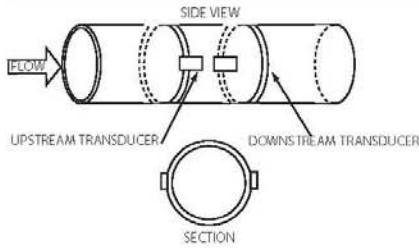

**Insertion Transducer**

DIMENSIONAL SPECIFICATIONS-STANDARD INSERTION SENSOR			
No.	Parts	No.	Parts
1	Cable	7	Set Screw
2	End Connector	8	O-Ring
3	O-Ring	9	Nut
4	Alignment Handle	10	Ball Valve
5	Locking Sleeve	11	Mounting Collar
6	Locking Collar	12	Transducer Housing

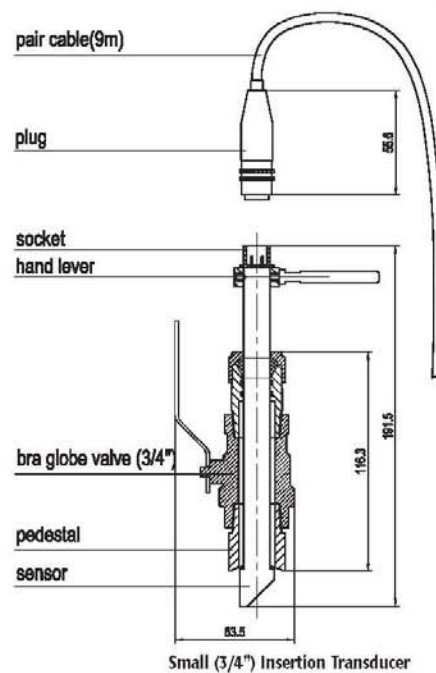
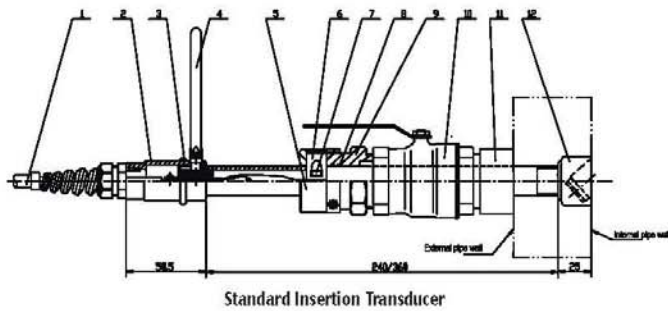

## 9. Appendix1 - Flow Application Data

### 9.1. Sound Velocity and Viscosity for Fluids Commonly Used

Fluid	Sound Velocity (m/s)	Viscosity
Water 20°C	1482	1.0
Water 50°C	1543	0.55
Water 75°C	1554	0.39
Water 100°C	1543	0.29
water125°C	1511	0.25
Water 150°C	1466	0.21
Water 175°C	1401	0.18
Water 200°C	1333	0.15
Water 225°C	1249	0.14
Water 250°C	1156	0.12
Acetone	1190	
Carbine	1121	

Ethanol	1168	
Alcohol	1440	1.5
Glycol	1620	
Glycerin	1923	1180
Gasoline	1250	0.80
Benzene	1330	
Toluene	1170	0.69
Kerosene	1420	2.3
Petroleum	1290	
Retinal	1280	
Aviation kerosene	1298	
Peanut oil	1472	
Castor oil	1502	

### 9.2. Sound Velocity for Various Materials Commonly Used

Pipe Material	Sound Velocity (m/s)
Steel	3206
ABS	2286
Aluminum	3048
Brass	2270
Cast iron	2460
Bronze	2270
Fiber glass-epoxy	3430
Glass	3276
Polyethylene	1950

PVC	2540
Titanium	3150
Cement	4190
Bitumen	2540
Porcelain enamel	2540
Glass	5970
Plastic	2280
Polyethylene	1600
PTFE	1450
Rubber	1600

### 9.3. Sound Velocity in Water (1 atm) at Different Temperatures

t(°C)	v(m/s)
0	1402.3
1	1407.3
2	1412.2
3	1416.9
4	1421.6
5	1426.1
6	1430.5
7	1434.8
8	1439.1
9	1443.2
10	1447.2
11	1451.1
12	1454.9
13	1458.7
14	1462.3
15	1465.8
16	1469.3
17	1472.7
18	1476.0
19	1479.1
20	1482.3
21	1485.3
22	1488.2
23	1491.1
24	1493.9
25	1496.6
26	1499.2
27	1501.8
28	1504.3
29	1506.7
30	1509.0
31	1511.3
32	1513.5
33	1515.7

34	1517.7
35	1519.7
36	1521.7
37	1523.5
38	1525.3
39	1527.1
40	1528.8
41	1530.4
42	1532.0
43	1533.5
44	1534.9
45	1536.3
46	1537.7
47	1538.9
48	1540.2
49	1541.3
50	1542.5
51	1543.5
52	1544.6
53	1545.5
54	1546.4
55	1547.3
56	1548.1
57	1548.9
58	1549.6
59	1550.3
60	1550.9
61	1551.5
62	1552.0
63	1552.5
64	1553.0
65	1553.4
66	1553.7
67	1554.0
68	1554.3

69	1554.5
70	1554.7
71	1554.9
72	1555.0
73	1555.0
74	1555.1
75	1555.1
76	1555.0
77	1554.9
78	1554.8
79	1554.6
80	1554.4
81	1554.2
82	1553.9
83	1553.6
84	1553.2
85	1552.8
86	1552.4
87	1552.0
88	1551.5
89	1551.0
90	1550.4
91	1549.8
92	1549.2
93	1548.5
94	1547.5
95	1547.1
96	1546.3
97	1545.6
98	1544.7
99	1543.9

Refer to the sound velocity of other fluids and materials, please contact the factory.

## 10. Appendix2 – Energy Meter



**Note: For Model 205i-1, there are TWO methods to perform energy meter function:**

1. If you do not select the RTD module, then the AI1 AI2 (4~20mA input ports) are open to connect temperature transmitters supplied by the customer.
2. If you chose the RTD module 205: NRG-2, then the AI1, AI2 inputs cannot be used.

### 10.1. Energy Meter Function

The flow meter has an energy meter function. The meter can calculate automatically caloric content of water under various temperatures, and obtain instantaneous caloric value and totalized caloric value. A separate customer-provided Temperature signal input is sent to the meter via the AI1, AI2 terminals, which can be configured for a 4~20mA or 0~20mA current signal.

### 10.2. Wiring

AI1, AI2 are connected with 2 temperature sensors by connection cable. The 2 temperature sensors are installed on the flow pipe and return pipe, they can input 4-20mA signals to AI1, AI2 of the transmitter (see wiring connection).

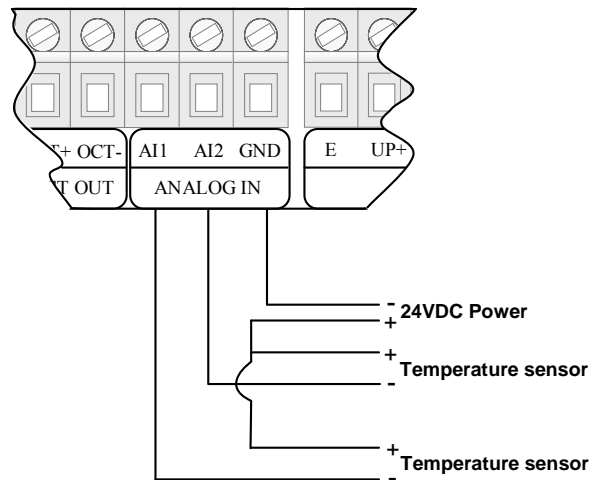

### 10.3. Energy Calculation Method

The flow meter has 2 calculation methods to achieve energy value:

Formula 1: Energy (caloric quantity) = Flow Value × Difference in Temperature × Specific Heat



**NOTE**

Select Energy units in window M84







Difference in Temperature: Difference in 2 analog input AI1, AI2 (transmitted from 2 temperature sensors)

Specific Heat: Input specific heat value in window M86, generally select Fixed Specific Heat value 0.0041868GJ/M3 for Water

Formula 2: Energy (caloric quantity) = Flow Value × Difference in Energy AI1 and Energy AI2

Energy (Instantaneous Caloric/Totalized Caloric) can be calculated automatically and display in window M05.

If the difference in Temperature is a fixed value, the meter can calculate Energy directly without temperature sensors. Enter Fixed Difference in Temperature value in window M85.

For example, we know Fixed Difference is 10□, press   ,   to select “ 1. Fixed Difference”, enter  . Energy can be calculated automatically and display in window M05.

## 10.4. Set Temperature Value Range

Input temperature signal via AI1, AI2 terminals, set its measurement range in window M63 and window M64.

For example, the inlet temperature sensor outputs a 4-20mA current signal to the meter, and this is set to represent a temperature range of 10°F to 50°F. Connect this sensor to the AI1 terminal, enter 10, 150 in window M63. Current mA value and temperature value of AI1 will display in window M06. The same procedure is then followed for the outlet temperature sensor; the zero and span for this sensor is entered into window M64

Related energy meter window as follows:

Window M05: Display energy and totalized energy

Window M06: Display AI1, AI2 current value and the corresponding temperature value

Window M63: Enter temperature value which AI1 4mA and 20mA analog input represent

Window M64: Enter temperature value which AI2 4mA and 20mA analog input represent

Window M85: Select energy units

Window M86: Select temperature source

Window M87: Specific heat value

Window M88: Select energy multiplier

Window M89: Reset energy totalizer

# 11. Appendix3—RTD Module and PT100 Wiring (Module optional)

## NOTE:



For Innova-Sonic 205i, there are 2 methods to perform energy meter function:

1. If the customer does not select the RTD module, then the AI1 AI2 (4~20mA input ports) are open to connect temperature transmitters supplied by the customer.
2. If the customer chooses to select the RTD module, then the AI1, AI2 inputs can not be used.

## 11.1. RTD Energy Meter Function

The RTD Module's main function is to input the temperature values for the energy measurement. The SIARRA 205 can automatically calculate the caloric content of water at different temperatures and deriving an instantaneous energy value and totalized energy value. Customers can connect PT100 sensors to the RTD module. The RTD module can convert the signals of temperature transducers to 4-20mA current signals and input them to the flow meter transmitter, or through the temperature transmitter to input 4-20mA signals directly (when RTD function is unavailable, use the ANALOG input).



## CAUTION

When using direct RTD input, the usage of the ANALOG IN Input to the transmitter's power supply board is forbidden.

## 11.2. Wiring

There are 2 wiring methods for the RTD module and PT100 temperature sensors — two-wire and three-wire connections.

When wiring with two wires, first jumper across A1 and B1 and A2 and B2 respectively, then connect PT100 sensors and to the RTD module according to the following diagram on the left. (Note: A1B1, A2B2 and C1C2 have the same wire color).

To connect the three wires, directly connect the PT100 sensors to the RTD module according to the following diagram on the right. (Note: A1, A2, B1, B2 are the same color, C1 and C2 are the same color).

RTD board can be adjusted by 4~20mA ports, the calibration has been completed in factory.

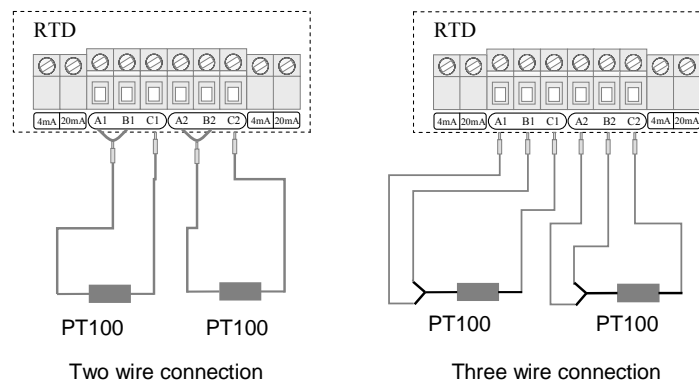

The two PT100 temperature sensors are installed on the inlet and return pipes and they will input temperature signals to the Innova-Sonic 205i transmitter.

### 11.3. Energy Measurement Methods

There are 2 formulas for flow meters to perform energy measurement functions:

**Formula 1:**  $Q = V \times C \times (T_1 - T_2)$

*Q*—Energy Value

*V*—Transit time water volume

*C*—Specific heat of the water

*T<sub>1</sub>*—Temperature value on the inlet side

*T<sub>2</sub>*—Temperature value on the return side

Notes:

Select energy units in window M84

Differential temperature: Temperature difference of Analog Input AI1, AI2 (transmitted from 2 temperature sensors)

Specific heat (C): Enter the specific heat in window M86 (generally select the fixed specific heat of 0.0041868GJ/M3 for water.

**Formula 2:**  $Q = m (h_1 - h_2)$

*Q*—Energy value

*m*—quality of the medium( density  $\times$  transit time water volume)

*h<sub>1</sub>*—enthalpy value of the inlet water

*h<sub>2</sub>*—enthalpy value of the return water

The temperature and pressure at the inlet and return water points can be measured by temperature sensors and a transmitter, and pressure sensors and a transmitter. Then the enthalpy value at the inlet and return water points can be calculated through the enthalpy values table. The flow of the medium can be measured via the ultrasonic flow sensors and 205I transmitter, and the caloric value can be derived according to the above formulas and the caloric calibration index.

### 11.4. Temperature Range Adjustment

Temperature signals are input from the 2 PT100 temperature sensors and the values of the measurement range are entered into Windows M63 and M64. These valves are FIXED at 0-180°C for the heat meter or -25 to 75°C for the chill meter.

Example: When the PT100 temperature is set to be 0°C, then the RTD module output is 4mA accordingly; when the PT100 temperature is set to be 180°C, then RTD module output is 20mA. The 4mA and 20mA corresponding to temperatures 0°C and 180°C are entered into window M63. The mADC value and the temperature value of AI1 and AI2 are displayed in Window M06.

**Related energy meter windows include:**

Window M05: Display transit-time energy value and totalized energy value

Window M06: Display mADC value and the corresponding temperature values of AI1, AI2 or the RTD module

Window M63: Enter the temperature values corresponding to AI1 4mA and 20mA analog inputs

Window M64: Enter the temperature values corresponding to AI2 4mA and 20mA analog inputs

Window M84: Energy units selection

Window M85: Temperature source selection

Window M86: Calorific capacity

Window M87: Energy totalizer switch

Window M88: Energy multiplier

Window M89: Reset energy totalizer

## 11.5. RTD Module Calibration Methods

There are two methods to calibrate the RTD module (customers can choose the proper one to calibrate according to the actual situation).

### **Method One: Resistance box calibration method**

**Note: The purpose is to calibrate the internal circuit of RTD module**

Tools needed: one DC resistance box, 3 wires (each wire less than 40mm long), and an instrument screwdriver.

1. RTD module A1 and B1 will need to be jumpered, and then connect B1 to one end of the DC resistance box, and C1 to the other end of the DC resistance box.
2. Power on the 205i transmitter, set menu M63 and menu M64 to be "0-180" and then enter menu M06.
3. Set the resistance value of the DC resistance box to be 100.00Ω.
4. Adjust the 4mA potentiometer on the left of A1, and make sure the display of AI1 is 4.0000 (as long as the displayed value is to be 4.00, the latter 2 decimal can be omitted).
5. Set resistance value of the DC resistance box to be 168.46Ω.
6. Adjust the 20mA potentiometer on the left of A1, and make sure the display of AI1 is 20.0000 (as long as the displayed value is to be 20.00, the latter 2 decimal can be omitted).
7. Jumper A2 and B2 the RTD module and then connect B2 to one end of the DC resistance box and C2 to the other end of the DC resistance box.
8. Power on the 205i transmitter, set menu M63 and menu M64 to "0-180" and then enter menu M06.
9. Set the resistance value on the DC Resistance box to be 100.00Ω.
10. Adjust the 4mA potentiometer on the right of C2 to make the display of AI2 is 4.0000, as long as the displayed value is 4.00, the latter 2 decimal can be omitted.
11. Set the resistance value of the DC Resistance box to be 168.46Ω.
12. Adjust the 20mA potentiometer on the right of C2 and make sure the display of AI2 reads 20.0000 (as long as the displayed value is to be 20.00, the latter 2 decimal can be omitted).

### **Method Two: Liquid standard temperature calibration method**

**Note: It is used to calibrate the internal circuit of RTD module and the PT100 temperature sensors together**

1. Directly put the sensor end of a PT100 temperature sensor into a mixture of ice and water (the temperature is 0°C), and the other end connects with the RTD module (adjust the electric potentiometer to 4mA accordingly to ensure the display of M63 is 4.00).
2. After the restoring the temperature sensors back to room temperature, put them into a constant temperature oil/water bath (the temperature is 180°C.) NOTE: The customer can choose the liquid temperature according to the actual requirements. Adjust the 20mA electric potentiometer accordingly to ensure the display in M63 is 20.00.
3. The calibration method of the other PT100 temperature sensor is the same as above.

### 11.6. Installation of RTD Module

Before installation of the RTD module (as indicated in the picture below) :

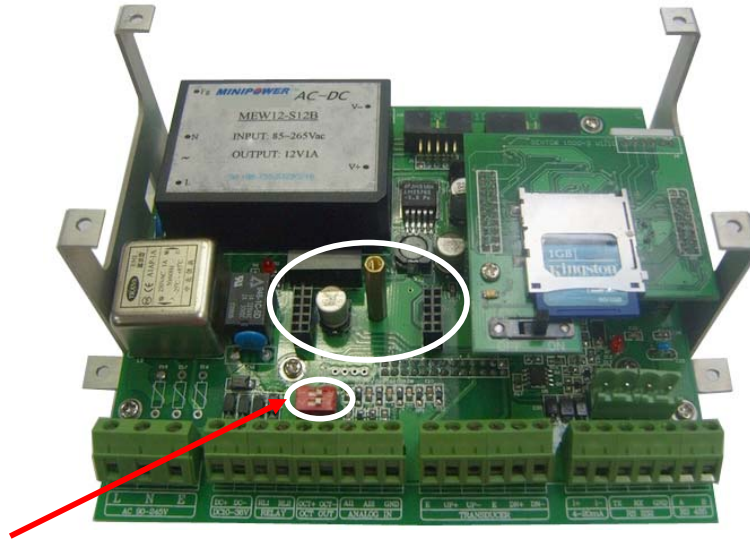

**ATTENTION**

Do not touch or move the red switch, otherwise the RS232 output and the flow meter will be damaged!

After installation (as indicated in the picture below):



**ATTENTION**

Do not touch or move the red switch, otherwise the RS232 output and the flow meter will be damaged!

# 12. Appendix4 - Wetted Transducer

## 12.1. Overview

Insertion transducers can be installed into metal pipelines via an isolation ball valve (installation into pipelines of plastic or other materials may require an optional coupling). The maximum pipe diameter in which insertion transducers can be installed is DN5000mm. Sensor cable length (9m standard) normally can be extended to as long as 305m. Follow the procedure below to install insertion transducers (If hot tapping is required, refer to the operating instructions of the manufacturer of hot tapping devices. Note that the pipe tap size should not be smaller than  $\phi 38\text{mm}$ ).

Figure 1 shows a diagram of the Insertion Transducer (Ordering option – W). The insertion transducer is attached to its mounting base (which is welded to the pipe section at the measurement point) via a ball valve. When the transducer is removed, pipe fluids can be contained by shutting off the ball valve. Therefore, installation and extraction of the transducer can be performed without relieving pipeline pressure. An O-ring seal and joint nut guarantee user safety while installing or operating the transducer.

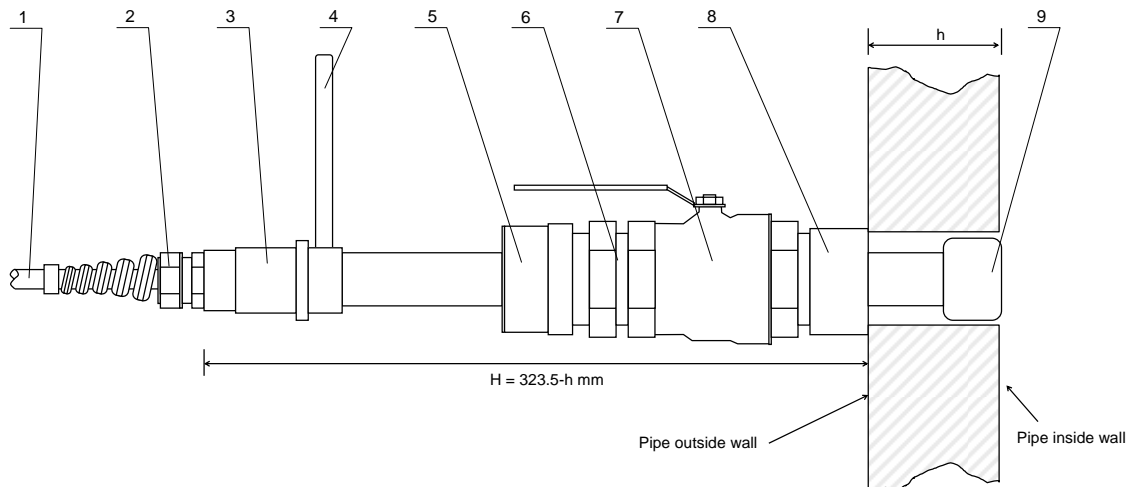

- |                                     |                       |
|-------------------------------------|-----------------------|
| 1. Cable                            | 6. Joint nut          |
| 2. Flexed-resistance revolved piece | 7. Ball valve         |
| 3. Connector                        | 8. Mounting base      |
| 4. Orientation handle               | 9. Transducer housing |
| 5. Locating sleeve                  |                       |

Fig.1 Construction Drawing of W type Transducer

## 12.2. Measurement Point Selection

To guarantee highly accurate measurement results, it is necessary to select an appropriate measurement point before installing the transducer. For examples of measuring point selection, see the related section in the manual.

## 12.3. Determining Transducer Spacing & Transducer Installation

To obtain the strongest signal strength and the most accurate measurement results, it is critical to ensure correct transducer spacing. Select an appropriate measurement point to install the transducer



### Important

When programming the instrument for use with Insertion Sensors, set the Pipe Wall Thickness in MENU 12 to 0.001. Set the "transducer Type" in MENU 23 as "0.Standard".

### Perform the following procedure to adjust the transducer spacing:

Calculate the center-to-center hole distance between the two transducers by using the formula below:

$$S = SP + 34 \text{ (Units in mm)}$$

In this formula, SP is the spacing value calculated (by the flow meter) by entering the pipe parameters such as pipe inner diameter, pipe wall thickness, etc. (Units in mm).

Drill holes 40mm in diameter at the determined measurement points on the pipe and weld the mounting base of the transducer vertically at that position on the pipe surface.

There are two transducer cables for the transducers: Upstream transducer cable with red terminal ends and downstream transducer cable with blue terminal ends. It should be noted that upstream transducer and downstream transducer must be installed at the appropriate measurement point in accordance with the flow direction. If the cable connection is reversed, opposite flow direction will be measured by the flow meter.

Tighten the ball valve securely onto the mounting base (shut off the ball valve).

Unscrew the locating sleeve and loosen the lock ring, retract the transducer into the joint nut, and then tighten the joint nut onto the ball valve.

Open the ball valve and insert the transducer into the pipe. At the same time, measure the dimension between the outside pipe and the A point (See Figure 1) and make sure it complies with the following formula:

$$H = 323.5 - h$$

In this formula:

H is Mounting height (mm)

323.5 is Transducer length (mm)

h is Pipe wall thickness (mm)

Attach the lock ring to the joint nut by fitting its pinhole in the locating pin, then tighten the screw slightly and turn the orientation handle until it points at the middle position between the two transducers and its axes matches the axes of the pipeline. Finally, tighten the locking screw and screw the locating sleeve onto the joint nut.

Connect the transducer cables to the corresponding upstream/downstream (upstream=red, downstream=blue) terminal ends.



### IMPORTANT

For horizontal pipelines, transducers must be fixed on the sides of the pipe (i.e. at the 3 and 9 o'clock position of the pipe) to prevent signal attenuation caused by sediment on the bottom of the pipe or air bubbles and air pockets in the top of the pipe.

## 12.4. Transducer Mounting Methods

Three transducer-mounting methods are available. Select one of them in the menu according to specific application conditions. They are: Z method, V method.

### 12.4.1 Z Mounting Method

Z method is the most commonly used mounting method for insertion-type ultrasonic flow meters, suitable for pipe diameters ranging from 50mm to 5000mm. Due to strong signal strength and high measurement accuracy, the Z method is preferable for pipe sections severely rusted or with too much scale formation on the inside wall. When installing the transducer using the Z method, be sure that the two transducers and the pipeline center axis are in the same plane, but never in the 6 or 12 o'clock positions. see below:

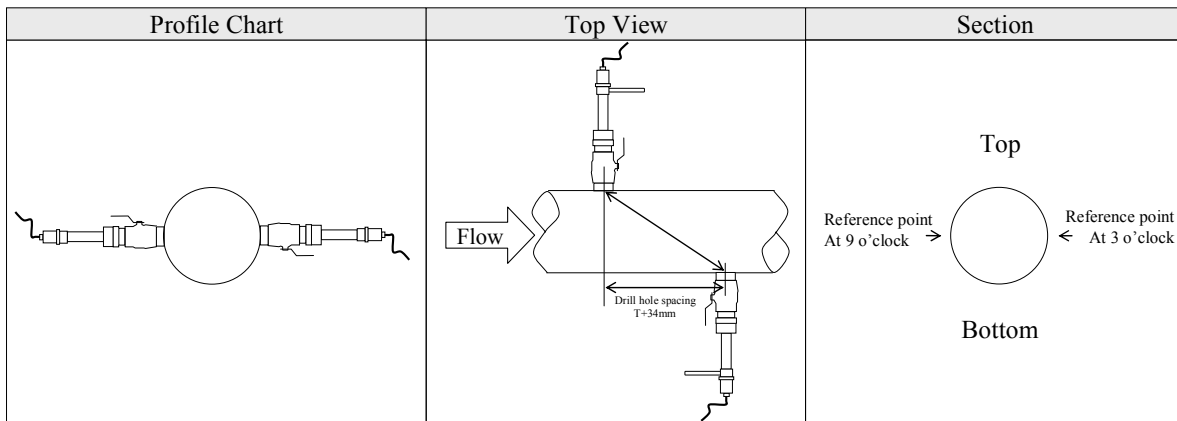

### 12.4.2 V Mounting Method

V method is suitable for pipe diameters ranging from 300mm to 1200mm. It is used when only one side of the pipe is available (example: the other side is against a wall) at the installation site, see below:

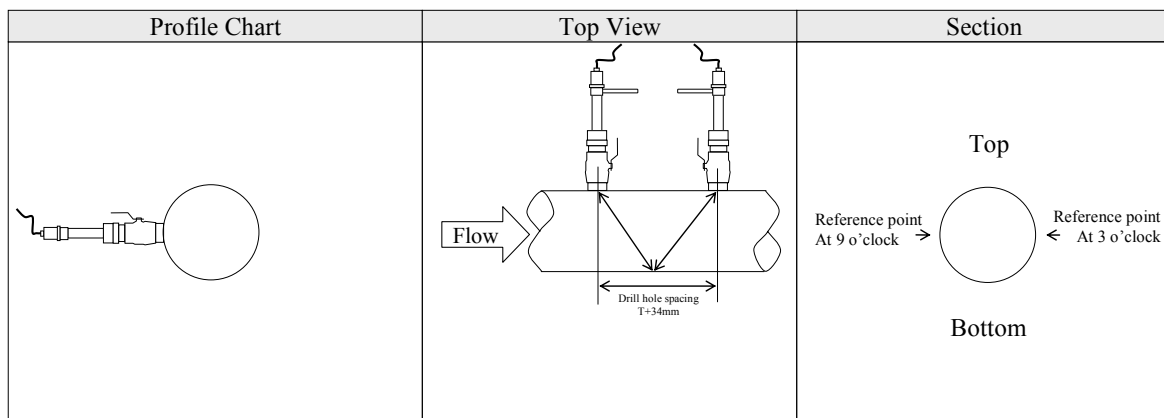

# 13. Appendix5 - Serial Interface Network Use and Communications Protocol

## 13.1. Overview

The flow meter has communication protocol. Its hardware directly supports a modem, a composition of flow data monitoring system that is economical, reliable and based on telephone line transmission. It can also be connected to a RS-485 bus through a RS232-RS485 change-over panel.

Two basic schemes can be chosen for networking, i.e. the analog current output method only using the flow meter or the RS232 communication method via serial port directly from the flow meter. This method is suitable to replace dated instruments in old monitoring networks. The later method is used in new monitoring network systems. Its advantages include low hardware investment and reliable system operation.

When the serial port communications method is directly used to implement a monitoring network system, the address identification code (in window M46) of the flow meter is used as a network address code. Expanded command set with [W] is used as communication protocol. Thus the analog current loop and OCT output of flow meter can be used to control the opening/closing of a control valve. The relay output can be used to power-on/off other equipment. The analog input of the system can be used to input signals such as pressure and temperature. The system provides an RTU function for flow measurement.

RS-232(cable length 0~15m) or RS-485(cable length 0~1000m) can be directly used for data transmission links for a short distance. Current loop, radio transmission and modem can be used in medium or long distance transmission.

When the flow meter is used in a network environment, various operations can be performed by a host device, except for programming of the address identification code, which needs to be done via the flow meter keyboard.

The command answer mode is used in data transmission, i.e. the host device issues commands and the flow meter answers correspondingly.

Common/special flow/thermal data monitoring system developed by our company can be used for flow data collection. Based on characteristics of the flow meter, the system makes full use of software and hardware designs with flow meter features. The system is simple, clear, economical, and reliable in operation.



### ATTENTION

In the communication protocol used functions, RS232 and RS485 serial communications can not be used at the same time.

## 13.2. Serial Port Definitions

Flow Meter:

- TXD receive
- RXD send
- GND

PC:

- PIN 1 not used
- PIN 2 RXD receive

PIN 3 TXD send  
 PIN 4 ground  
 PIN 5 ground  
 PIN 6 not used  
 PIN 7 not used  
 PIN 8 not used  
 PIN 9 empty

### 13.3. Direct Connection via RS232 to the Host Device

See the above list of flow meter serial port definitions.

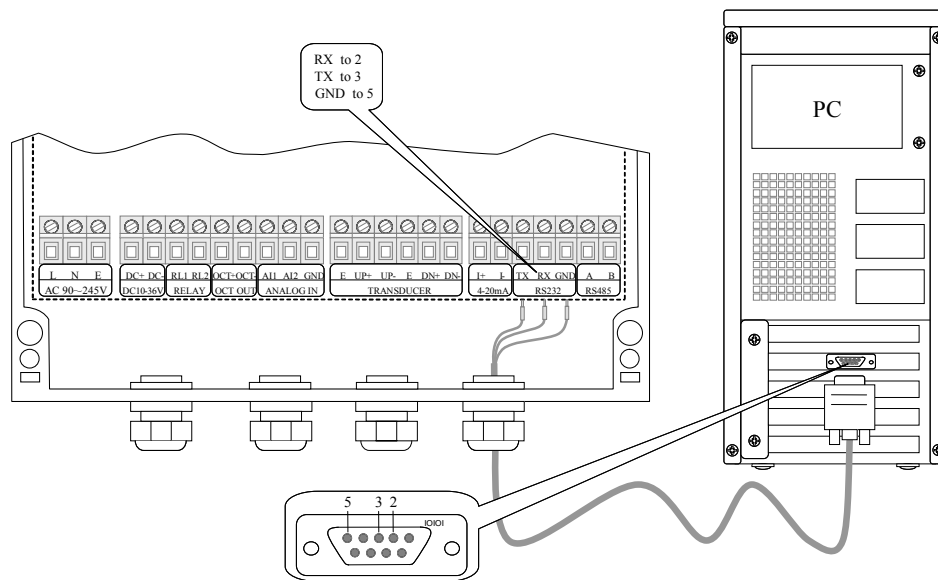

### 13.4. Communications Protocol and The Use

The Innova-Sonic 205i supports these three communication protocols: FUJI Protocol, MODBUS-C Protocol, MODBUS-I Protocol. Refer to Menu 96 for the protocol selection.



#### NOTICE

A wrong flow meter protocol setting will lead to abnormal communications.

#### 13.4.1 FUJI Protocol

Choose "0.FUJI" in Menu 96 for FUJI Protocol.

The communication protocol format used by the ultrasonic flow meter is an expanded set of the Fuji FLV series flow meter protocol. The host device requests the flow meter to answer by sending a "command". The baud rate of asynchronous communication (Primary station: computer system; Secondary station: ultrasonic flow meter) is generally 9600BPS. A single byte data format (10 bits): one start bit, one stop bit and 8 data bits. Check bit: none.

A data character string is used to express basic commands and a carriage return (ENTER) is used to express the end of a command. The order applies to both RS232 and RS485. The characteristic is that the string of data is flexible. Frequently used commands are as follows:

Communications commands

Command	Description	Data format
DQD(cr)(lf)*0	Return daily instantaneous flow	±d.dddE±dd(cr) *1
DQH(cr)(lf)	Return hourly instantaneous flow	±d.dddE±dd(cr)
DQM(cr)(lf)	Return instantaneous flow per minute	±d.dddE±dd(cr)
DQS(cr)(lf)	Return instantaneous flow per second	±d.dddE±dd(cr)
DV(cr)(lf)	Return instantaneous velocity	±d.dddE±dd(cr)
DI+(cr)(lf)	Return positive accumulative flow	±dddE±d(cr) *2
DI-(cr)(lf)	Return negative accumulative flow	±dddE±d(cr)
DIN(cr)(lf)	Return net increment	±dddE±d(cr)
DIE(cr)(lf)	Return totalized energy value	±dddE±d(cr)
E(cr)(lf)	Return instantaneous energy value	±dddE±d(cr)
AI1(cr)(lf)	Return analog input value of AI1 (Temperature,Pressure,etc.)	±dddE±d(cr)
AI2(cr)(lf)	Return analog input value of AI2 (Temperature,Pressure,etc.)	±dddE±d(cr)
AI3(cr)(lf)	Return analog input value of AI3 (Temperature,Pressure,etc.)	±dddE±d(cr)
AI4(cr)(lf)	Return analog input value of AI4 (Temperature,Pressure,etc.)	±dddE±d(cr)
DID(cr)(lf)	Return identification code of instrument (address code)	ddd(cr) 5 bits in length
DL(cr)(lf)	Return signal intensity	UP:dd.d, DN:dd.d, Q=dd(cr)
DS(cr)(lf)	Return percentage of analogous output (AO)	±d.dddE±dd(cr)
DC(cr)(lf)	Return current error code	*3
DA(cr)(lf)	Alarm signal of OCT or RELAY	TR:s, RL:s(cr) *4
DT(cr)(lf)	Current date and time	yy-mm-dd, hh:mm:ss(cr)
M@(cr)(lf)	Analogous key value @ sent to flow meter	M@(cr) *5
LCD(cr)(lf)	Return currently displayed content on LCD display	
C1(cr)(lf)	OCT actuated	
C0(cr)(lf)	OCT not actuated	
R1(cr)(lf)	RELAY actuated	

R0(cr)(lf)	RELAY not actuated	
FOddd(cr)(lf)	Frequency output value n	Fddd(cr)(lf)
Aoa(cr)(lf)	Current output value a of current loop	AOa(cr)(lf) *6
ESN(cr)(lf)	Return electronic serial number	ddddddt(cr)(lf) *7
N	Networking command prefix of a single byte address	*8
W	Networking command prefix of numeric string address	*8
P	Prefix of return command with check	
&	Function sign of command "add"	
RING(cr)(lf)	Modem request handshake command	ATA(CR)(lf)
OK(cr)(lf)	Modem answer signal	No output
	Flow Meter request handshake signal	AT(CR)(LF)

Note:

0. (cr)expresses carriage return. Its ASCII value is 0DH. (lf) expresses line feed. Its ASCII value is 0AH.
1. "d" expresses 0-9 number. 0 value is expressed as +0.000000E+00.
2. "d" expresses 0-9 numbers. There is no decimal point in integral part before "E".
3. The status of the machine is expressed by 1-6 letters. See the error code section for the meaning of the characters. For example, "R" and "IH".
4. "s" expresses ON or OFF or UD. For example, "TR:ON, RL:ON" expresses that the OCT and relay are in an actuated status; "TR:UD, RL:UD" expresses that the OCT and relay are not actuated.
5. "@" expresses the key value. For example, 30H expresses "0" key; Command "M4" is equivalent to pressing the key "4".
6. "a" expresses the current value. The value range is 0-20. For example, AO2.34567 and AO0.2.
7. Eight "ddddddd" expresses the electronic serial number of the machine. "t" expresses the type of machine.
8. If there are multiple flow meters in a data network then the basic commands cannot be used alone. The prefix N or W must be added. Otherwise, multiple flow meters will answer simultaneously, which will cause chaos in the system.

### 13.4.1.1. Function Prefix and Function Sign

#### Prefix P

The character P can be added before every basic command. It means that the transferred data has CRC verification. The method of counting the verified sum is achieved by binary system addition.

For example: Command DI+(CR) (the relative binary system data is 44H, 49H, 2BH, 0DH) transferred data is +1234567E+0m3. (CR) (the relative binary system data is 2BH, 31H, 32H, 33H, 34H, 35H, 36H, 37H, 45H, 2BH, 30H, 6DH, 33H, 20H, 0DH, 0AH). And command PDI+ (CR) transferred data is +1234567E+0m3! F7 (CR), "!" means the character before it is the sum character, and the verified sum of

the two bytes after it is (2BH+31H+32H+33H+34H+35H+ 36H+37H+45H+2BH+30H+6DH+33H+20H  
=(2)F7H)

Note: there can be no data before “!”, and also may be a blank character.

### **Prefix W**

Usage of prefix W: W+ numeric string address code +basic command. Value range of the numeric string is 0~65535, except 13 (0DH carriage return), 10 (0AH line feed), 42 (2AH \*) and 38 (26H &). If the instantaneous velocity of No. 12345 flow meter is to be accessed, the command W12345DV(CR) can be issued. Corresponding binary code is 57H, 31H, 32H, 33H, 34H, 3 5H, 44H, 56H and 0DH

## Function sign &

Function sign & can add up to 5 basic commands (Prefix P is allowed) together to form a compound command sent to the flow meter together. The flow meter will answer simultaneously. For example, if No. 4321 flow meter is requested to simultaneously return: 1] instantaneous flow, 2] instantaneous flow velocity, 3] positive total flow, 4] energy total, 5] All analog input current value, the following command is issued:

```
W4321PDQD&PDV&PDI+&PDIE&PBA1(CR)
Simultaneously returned data are likely as follows:
+0.000000E+00m3/d!AC(CR)
+0.000000E+00m/s!88(CR)
+1234567E+0m3 !F7(CR)
+0.000000E+0GJ!DA(CR)
+7.838879E+0mA!59(CR)
```

### 13.4.1.2. Key Code

In a network environment, a key code is used to simulate the use of keys at the host device.

For example, the instruction “M1” is input through the serial port, which is equivalent to pressing Key 1 on the keyboard of the ultrasonic flow meter.

Codes:

Key	Key Code (Hexadecimal system)	Key Code (Decimal system)	ASCII
0	30H	48	0
1	31H	49	1
2	32H	50	2
3	33H	51	3
4	34H	52	4
5	35H	53	5
6	36H	54	6
7	37H	55	7
8	38H	56	8
9	39H	57	9
.	3AH	58	:
<	3BH (0BH)	59	;
Menu	3CH (0CH)	60	<
Enter	3DH (0DH)	61	=
^	3EH	62	>

(V)	3FH	63	?
-----	-----	----	---

### 13.4.2 MODBUS-C Protocol

Choose “1. MODBUS-C” in Menu 96 for MODBUS-C Protocol.

This MODBUS-C Protocol uses the RTU transmission mode. The Verification Code uses CRC-16-CCITT (polynomial is  $X^{16}+X^{12}+X^5+1$ , shield character is 0x1021) which is obtained by the cyclic redundancy algorithm method.

Read the information sent by the host (controller):

Slave flow meter Address	Operating Function Code	First address of Register (Code No.)	Registry number	Error Check (2 bytes)
(0x00-0xfe)	0x03	0x00	(0x11)	CRC (Verify)

(Table 1)

The slave meter receives information frames from host successfully, and the command is validated, then the slave device sends out a return signal. The frame format is shown below:

Slave flow meter Address	Read Operation Function Code	Data Bytes	Number of Data Bytes N	Error Check (Only for data redundancy)
(0x00-0xfe)	0x03	(0x11)		CRC (Verify)

(Table 2)

The range of slave flow meter addresses is from 0 to 254. For example: Address = 00019 (it can be checked in the Menu 46), decimal number 19, converts the address into 1-byte hexadecimal data 0x13, and then the address of the slave flow meter in the MODBUS protocol is: 0x13. The following slave addresses are unavailable: 13 (0DH), 10 (0AH), 42 (2AH), 38 (26H).

The first address (code) of the data registry and the number of the registry are the meter's data transmitted via MODBUS. Refer to table 3 for definitions:

Parameter	First address register (number)	registry number	Error Check (calculate 3 bytes)
Instantaneous Flow Rate (m3/ hour)	0x00	0x11	0x5b40
Positive Totalizer	0x11	0x0e	0x88dc
Negative Totalizer	0x1f	0x0e	0xabd3
Totalizer	0x2d	0x0e	0xc824
Instantaneous Energy Flow Rate	0x3b	0x12	0xb24c
Energy Totalizer	0x4d	0x0f	0xd32f
Analog input value 1	0x5c	0x0d	0xc32f
Analog input value 2	0x69	0x0d	0x394f

Analog input value 3	0x76	0x0d	0x2a02
Analog input value 4	0x83	0x0d	0xc636

(Table 3)

Error Check: uses the CRC verification method, using the standard CCITT polynomial method (See Table 4).

Error check is formed using 16-bit with high 8-bit bytes in the beginning and low 8-bit bytes at the end. 8-bit bytes of the first high-and low 8-bit bytes in the post

Specification	Generating Polynomial	Shorthand
CRC16-CCITT	$X^{16}+X^{12}+X^5+1$	0x1021

(Table 4)

Example:

The host sends out : 0x10 0x03 0x00 0x11 CRC code high byte CRC code low byte.

The slave flow meter receives the information frame sent by the host and evaluates the command as follows:  
Reads daily instantaneous flow rate from slave flow meter with address 0x10 (decimal 16).

The slave flow meter responds to the host : 0x10 0x03 0x11 17 bytes of data CRC code high byte CRC code low byte (CRC comes from cyclic redundancy of 17 data bytes)

Reading Parameters	Command Frame Sent by Host
Instantaneous Flow Rate (m3/hour)	100300115b40
Positive Totalizer	1003110e88dc
Negative Totalizer	10031f0eabd3
Totalizer	10032d0ec824
Instantaneous Energy Flow Rate	10033b12b24c
Energy Totalizer	10034d0fd32f
Analog input value 1	10035c0dc32f
Analog input value 2	1003690d394f
Analog input value 3	1003760d2a02
Analog input value 4	1003830dc636

### 13.4.3 MODBUS-I Communication Protocol

Choose "2. MODBUS-I" in Menu 96 for MODBUS-I Protocol.

This MODBUS-I Protocol uses RTU transmission mode. The Verification Code uses CRC-16-IBM (polynomial is  $X^{16}+X^{15}+X^2+1$ , shield character is 0xA001) which is gained by the cyclic redundancy algorithm method.

MODBUS-I RTU mode uses hexadecimals to transmit data.

#### 1) MODBUS-I Protocol Function Code and Format

The flow meter protocol supports the following two-function codes of the MODBUS:

Function Code	Performance data
0x03	Read register
0x06	Write single register

## 2) MODBUS Protocol function code 0x03 usage

The host sends out the read register information frame format:

Slave Address	Operation Function Code	First Address Register	Register Number	Verify Code
1 byte	1 byte	2 bytes	2 bytes	2 bytes
0x01~0xF7	0x03	0x0000~0xFFFF	0x0000~0x7D	CRC(Verify)

The slave returns the data frame format:

Slave Address	Read Operation Function Code	Number of Data Bytes	Data Bytes	Verify Code
1 byte	1 byte	1 byte	N*x2 byte	2 byte
0x01~0xF7	0x03	2xN*	N*x2	CRC(Verify)

N\* = data register number

## 3) MODBUS Protocol function code 0x06 usage

The host sends a command to write a single register information frame format (performance code 0x06):

Slave Address	Operation Function Code	Register Address	Register Data	Verify Code
1 byte	1 byte	2 bytes	2 bytes	2 bytes
0x01~0xF7	0x06	0x0000~0xFFFF	0x0000~0xFFFF	CRC(Verify)

The slave returns the data frame format (performance code 0x06):

Slave Address	Operation Function Code	Register Address	Register Data	Verify Code
1 byte	1 byte	2 bytes	2 bytes	2 bytes
0x01~0xF7	0x06	0x0000~0xFFFF	0x0000~0xFFFF	CRC(Verify)

The range of flow meter addresses 1 to 247 (Hexadecimal: 0x01~0xF7), and can be checked in the Menu 46. For example, decimal number "11" displayed on Menu 46 means the address of the flow meter in the MODBUS protocol is 0x0B.

The CRC Verify Code adopts CRC-16-IBM (polynomial is  $X^{16}+X^{15}+X^2+1$ , shield character is 0xA001) which is

gained by the cyclic redundancy algorithm method. Low byte of the verify code is at the beginning while the high byte is at the end.

For example, to read the address 1 (0x01) in the RTU mode, if the instantaneous flow rate uses hour as a unit (m<sup>3</sup>/h) , namely reads 40005 and 40006 registers data, the read command is as follows:

0x01            0x03            0x00 0x04            0x00 0x02            0x85 0xCA

Flow Meter Address    Function Code    First Address Register    Register Numbers    CRC Verify Code

Flow Meter returned data is (assuming the current flow=1.234567m<sup>3</sup>/h)

0x01            0x03            0x04            0x06 0x51 0x3F 0x9E 0x3B 0x32

Flowmeter Address    Function Code    Data Bytes    Data (1.2345678)            CRC Verify Code

The four bytes 3F 9E 06 51 is in the IEEE754 format single precision floating point form of 1.2345678.

Pay attention to the data storage order of the above example. Using C language to explain the data, pointers can be used directly to input the required data in the corresponding variable address, the low byte will be put at the beginning, such as the above example 1.2345678 m/s, 3F 9E 06 51 data stored in order as 51 06 9E 3F.

For example, it converts the address 1 (0x01) to 2 (0x02) under the RTU mode, so to write the data of flowmeter 44100 register as 0x02, the write command is as follows:

0x01            0x06            0x10 0x03            0x00 0x02            0xFC 0xCB

Flowmeter Address    Function Code    Register Address    Register Number    CRC Verify Code

Flowmeter returned data is:

0x01            0x06            0x10 0x03            0x00 0x02            0xFC 0xCB

Flowmeter Address    Function Code    Register Address    Register Number    CRC Verify Code

#### 4) Error Check

The flow meter only returns one error code 0x02 which means data first address in error.

For example, to read address 1 (0x01) of the flow meter 40002 register data in the RTU mode, the flow meter considers it to be invalid data, and sends the following command:

0x01            0x03            0x00 0x01            0x00 0x01            0xD5 0xCA

Flowmeter Address    Function Code    Register Address    Register Number    CRC Verify Code

Flowmeter returned error code is:

0x01            0x83            0x02            0xC0 0xF1

Flowmeter Address    Error Code    Error Extended Code    CRC Verify Code

#### 5) MODBUS Register Address List

The flow meter MODBUS Register has a read register and a write single register.

##### a) Read Register Address List (use 0x03 performance code to read)

PDU Address	Register	Read	Write	Type	No. registers*
\$0000	40001	Flow/s - low word	32 bits real	2	
\$0001	40002	Flow/s - high word			
\$0002	40003	Flow/m - low word	32 bits real	2	
\$0003	40004	Flow/m- high word			
\$0004	40005	Flow/h - low word	32 bits real	2	
\$0005	40006	Flow/h - high word			

\$0006	40007	Velocity – low word	32 bits real	2	
\$0007	40008	Velocity – high word			
\$0008	40009	Positive total – low word	32 bits int.	2	
\$0009	40010	Positive total – high word			
\$000A	40011	Positive total – exponent	16 bits int.	1	
\$000B	40012	Negative total – low word	32 bits int.	2	
\$000C	40013	Negative total – high word			
\$000D	40014	Negative total – exponent	16 bits int.	1	
\$000E	40015	Net total – low word	32 bits int.	2	
\$000F	40016	Net total – high word			
\$0010	40017	Net total – exponent	16 bits int.	1	
\$0011	40018	Energy total – low word	32 bits int.	2	
\$0012	40019	Energy total – high word			
\$0013	40020	Energy total – exponent	16 bits int.	1	
\$0014	40021	Energy flow – low word	32 bits real	2	
\$0015	40022	Energy flow – high word			
\$0016	40023	Up signal int – low word	32 bits real	2	0~99.9
\$0017	40024	Up signal int – high word			
\$0018	40025	Down signal int – low word	32 bits real	2	0~99.9
\$0019	40026	Down signal int – high word			
\$001A	40027	Quality	16 bits int.	1	0~99
\$001B	40028	Analog output – low word	32 bits real	2	Unit: mA
\$001C	40029	Analog output – high word			
\$001D	40030	Error code – char 1,2	String	3	Refer to “Error Analysis” for detailed codes meanings.
\$001E	40031	Error code – char 3,4			
\$001F	40032	Error code – char 5,6			
\$003B	40060	Velocity unit – char 1,2	String	2	Currently supports m/s only
\$003C	40061	Velocity unit – char 3,4			
\$003D	40062	Flow unit – char 1,2	String	2	Note 1
\$003E	40063	Flow unit – char 3,4			
\$003F	40064	Total unit – char 1,2	String	1	
\$0040	40065	Energy unit – char 1,2	String	2	Note 2- the setup is same as M84 and M85
\$0041	40066	Energy unit – char 3,4			
\$0042	40067	Energy total unit – char 1,2	String	1	
\$0043	40068	ID code – low word	32 bits int.	2	
\$0044	40069	ID code – high word			
\$0045	40070	Serial number – char 1,2	String	4	
\$0046	40071	Serial number – char 3,4			
\$0047	40072	Serial number – char 5,6			
\$0048	40073	Serial number – char 7,8			
\$0049	40074	Analog Input AI1 Value- low word	32 bits real	2	Returned temperature value with RTD option
\$004a	40075	Analog Input AI1 Value- high word			
\$004b	40076	Analog Input AI2 Value- low word	32 bits real	2	Returned temperature

\$004c	40077	Analog Input AI2 Value-high word			value with RTD option
--------	-------	----------------------------------	--	--	-----------------------

b) Single Write Register Address List (use 0x06 performance code to write)

PDU Address	Register	Description	Read/Write	Type	No. registers*
\$1003	44100	Flowmeter address (1-247)	R/W	16 bits int.	1
\$1004	44101	Communication Baud Rate 1 = 4800, 2 = 9600 3 = 19K2, 4 = 38K4 ,5 = 57K6	R/W	16 bits int.	1

Notes:

1. The following flow rate units are available:
  0. "m3" —Cubic Meter
  1. "l" —Liters
  2. "ga" —Gallons
  3. "ig" —Imperial Gallons
  4. "mg" —Million Gallons
  5. "cf" —Cubic Feet
  6. "ba" —US Barrels
  7. "ib" —Imperial Barrels
  8. "ob" —Oil Barrels
2. The following energy units are available:
  0. "GJ" —Giga Joule
  1. "Kc" —Kilocalorie
  2. "MB" —MBtu
  3. "KJ" —Kilojoule
  4. "Bt" —Btu
  5. "Ts" —US Tonnes
  6. "Tn" —US Tons
  7. "kw" —Kwh
3. When the flowmeter address or communication baud rate change, the meter will work under the new address or communication baud rate after the communication baud rate responded with returned primary address and communication baud rate.
4. 16 bits int—short integer, 32 bits int – long integer, 32 bits real—floating point number, String—alphabetic string

